

MY LIFE DESIGN STORIES

NIGHT COLLECTION

FURNITURE DESIGNED WITH A NEW
PERSPECTIVE TO ENHANCE STYLE AND
COMFORT FOR THE PRIVATE SPACE. 2017

Poliform

NIGHT COLLECTION 2017

THE COMPANY pag 2

INTERIOR 01 pag 10

Kelly letto/bed design Emmanuel Gallina, Ego armadi/wardrobes design Giuseppe Bavuso
Bangkok armadi/wardrobes design Operadesign, Quid boiserie/wall panelling design CR&S Poliform

INTERIOR 02 pag 38

Rever letto/bed design Rodolfo Dordoni, Skin armadi/wardrobes design CR&S Poliform
Ubik cabina armadio/walk-in closet design CR&S Poliform

INTERIOR 03 pag 64

Dream letto/bed design Marcel Wanders, New Entry armadi/wardrobes design CR&S Poliform
Senzafine cabina armadio/walk-in closet design Rodolfo Dordoni, Jacqueline letto/bed design Jean-Marie Massaud

INTERIOR 04 pag 96

Bruce letto/bed design Jean-Marie Massaud, Ocean armadi/wardrobes design CR&S Poliform
Fitted armadi/wardrobes design Rodolfo Dordoni, Quid boiserie/wall panelling design CR&S Poliform

INTERIOR 05 pag 120

Onda letto/bed design Paolo Piva, Bangkok armadi/wardrobes design Operadesign
Ubik cabina armadio/walk-in closet design CR&S Poliform

INTERIOR 06 pag 146

Bolton letto/bed design Giuseppe Viganò, Fitted armadi /wardrobes design Rodolfo Dordoni
Senzafine cassettera ad isola/free-standing drawer unit design CR&S Poliform

INTERIOR 07 pag 168

Laze letto/bed design Rodolfo Dordoni
Fitted armadi/wardrobes design Rodolfo Dordoni

INTERIOR 08 pag 194

Arca letto/bed design Paolo Piva, Fitted armadi/wardrobes design Rodolfo Dordoni
Senzafine cabina armadio/walk-in closet design Rodolfo Dordoni

TECHNICAL DATA pag 219

dati tecnici

L'estetica del relax. Uno spazio privato, intimo, pensato per soddisfare con eleganza ed esclusività il bisogno di privacy nell'abitare contemporaneo. La zona notte di Poliform si esprime attraverso arredi di gusto dall'estetica coordinata con i quali definire uno stile e dare forma compiuta agli ambienti. Armadi, cabine armadio, letti e complementi si declinano in un'ampia gamma di proposte che differiscono per materiali, colori e finiture che permettono di risolvere aspetti funzionali grazie alla ricchezza di accessori e attrezzature interne.

The look of relaxation. A private, intimate space, designed to meet the privacy needs of contemporary living with a touch of elegance and exclusivity. The Poliform bedroom collection is expressed through elegant, perfectly coordinated furniture, creating a distinct style and a total look for the entire home. Wardrobes, walk-in closets, beds and bedroom sets are developed into a broad range of proposals distinguished by their use of materials, colours and finishes, creating practical compositions thanks to a rich range of accessories and inner equipment.

Un gruppo industriale di livello internazionale ma fortemente radicato nel territorio della Brianza, terra fertile per eccellenza per la cultura dell'arredo, e legato da sempre a Milano, culla del design e della progettazione italiana e internazionale. Un percorso all'insegna della creatività legata a doppio filo alla produzione, della coerenza di pensiero che si declina in progetti diversi, della cultura di fare mobili influenzata dalla dimensione internazionale. Sempre attraverso un linguaggio definito, con la consapevolezza delle proprie origini e la capacità di guardare il futuro con la qualità e l'eccellenza sempre al primo posto. Dall'impresa artigiana del 1942 alla fondazione dell'azienda nel 1970, dalle storiche collaborazioni con architetti e progettisti internazionali alla dimensione attuale con ben sette sedi aziendali situate nel raggio di pochi chilometri, e una superficie complessiva di 115.000 mq tra produzione, centro direzionale e showroom. Poliform è tutto questo, è coerenza stilistica declinata in ogni ambiente della casa, dalla zona giorno a quella notte e riproposta anche in cucina grazie a Varenna, grazie a sistemi integrati che sono parte essenziale di una proposta omogenea e coordinata. È una produzione 100% Made in Italy, è attenzione per i dettagli, ai materiali di qualità, all'innovazione tipologica, per una gamma di soluzioni rivolte a un pubblico eterogeneo e multiculturale. Poliform è un senso di appartenenza, è armonia di stile, è un progetto coordinato e completo per l'ambiente domestico e non solo, è la consapevolezza di far parte di 70 anni di una storia, scandita da episodi unici e irripetibili, è la continua volontà di progettare mobili per case sempre più esclusive e straordinarie.

A global industrial group, Poliform has roots in Brianza, a breeding ground for excellence in furniture-making close to the cradle of international design and home furniture - Milan. Poliform represents a journey driven by creativity and production excellence, a history shaped by a unified design vision, a culture of making furniture with international influences, and a brand that reflects not only the company's roots but also its future. Grown from an artisanal business in 1942 to the larger operation established in 1970, Poliform's headquarters today are comprised of an impressive network of seven campuses located within a few kilometers from each other, with 115,000 square meters of production facilities, executive offices and showrooms. Poliform provides a consistent style through the entire home, from the living room to the bedroom and the kitchen - with Varenna - through the use of integrated systems that form the essentials of rational, well-coordinated compositions. What makes Poliform distinct is its production, which is 100% Made in Italy, attention to detail, quality materials, design innovation, and its range of solutions aimed towards answering the diverse needs of home consumers around the world. Poliform offers a sense of belonging and a harmonious style, a coordinated and complete home, informed by the company's awareness of its place in a 70-year history marked by innovation. Poliform continues its mission to design furniture for homes that are exclusive, and extraordinary.

THE SEARCH FOR
QUALITY AND INNOVATION,
GUIDE LINES THAT FOLLOW
THROUGH EVERY
COMPANY DECISIONS.

Qualità ed eccellenza contemporanea.

Innovazione sotto ogni aspetto, qualità ed eccellenza come linee guida, attenzione e rispetto per l'identità di ogni materiale, tipologia di essenza, finitura o trattamento superficiale. La cultura del "fare bene le cose" guida tutta la produzione Poliform, dall'idea al prodotto finito, dalle lavorazioni artigianali a quelle più industrializzate e si traduce in sistemi giorno e notte che esprimono un linguaggio contemporaneo fatto di linee semplici, proporzioni misurate, equilibrio estetico assoluto per un lusso sofisticato e mai ostentato. Una qualità che gli arredi Poliform trasmettono all'abitare, un'eccellenza che viene da lontano, da un know how unico nella lavorazione del legno che si rinnova ogni giorno anche approfondendo le caratteristiche degli altri materiali. Una conoscenza su cui si innestano innovazione e ricerca continua finalizzate ad elevare gli standard di ogni prodotto anche in merito ad aspetti "intangibili", quelli che non si vedono ma che spesso fanno la differenza perché indice di una cura che va al di là dell'aspetto formale. Poliform "produce qualità" totale e la esprime in ogni arredo, sistema o collezione.

Versatilità delle soluzioni.

Capaci di integrarsi in ogni spazio, perché flessibili e versatili anche se con una forte identità, per dar vita a configurazioni diverse per dimensioni, estetica e rapporto con l'architettura dello spazio e con tutti i suoi componenti. Sistemi componibili, imbottiti, letti e complementi in grado di trasformarsi e arricchirsi di nuove finiture, per soddisfare un gusto trasversale attraverso varietà stilistiche e formali sia nella zona giorno che nella zona notte. Le collezioni Day & Night Poliform fanno della personalizzazione e dell'esclusività i tratti distintivi, alimentando una ricerca stilistica che anticipa i trend contemporanei nel settore arredo. Soluzioni coordinate, contraddistinte da accostamenti ricercati, contaminazioni di stile e da continui dialoghi e rimandi tra elementi diversi. I materiali naturali esprimono la propria esclusività attraverso texture elaborate, le forme rigorose valorizzano al meglio l'essenza della materia, le collezioni esplorano affinità diverse proponendosi anche come soluzioni chiavi in mano per ambiti diversi da quello residenziale. Poliform Contract si propone come interlocutore di livello assoluto sia per la qualità delle soluzioni che per il servizio affidabile e puntuale, per affrontare progetti internazionali di grande prestigio e dare forma ad esperienze e stili di vita contemporanei.

Quality and contemporary excellence.

Innovation in all its forms, guided by quality and excellence, care and respect for the properties of each material, each type of wood, finish, or surface treatment. Poliform production is based on a culture of "doing things well", from the initial idea to the finished product, from manual workmanship to industrialised processes, bringing to life day and night solutions with a contemporary feel made of simple lines and calculated proportions, creating a totally balanced look for sophisticated, yet discrete luxury. Quality that Poliform furniture spreads throughout the home, excellence that comes from afar, from unique woodworking expertise renewed day after day, while also enhancing the properties of other materials. Knowledge inscribed with innovation and continuous research in a constant effort to improve product standards, including the "intangible" aspects, the ones invisible to the eye but which often make the difference insofar as a sign of attention to detail going well beyond form. Poliform "produces total quality" and expresses it in every item of furniture, system or collection.

Versatile solutions.

The ease with which they can be inserted into any space thanks to their flexibility and versatility, in spite of their strong identity, giving life to different configurations in terms of their dimensions, look and relationship with the surrounding architecture and all its components. Modular systems, upholstered elements, beds and accessories transformed and embellished by new finishes, satisfying all kinds of tastes through a variety of styles and forms in both the living area and the bedroom. The Day & Night Poliform collections are set apart by their personalisation and exclusivity, nourishing a search for style that is always one step ahead of contemporary home interior furniture trends. Coordinated solutions distinguished by strategic combinations, a fusion of styles featuring continuous dialogue and references between the different elements. Natural materials express their exclusivity through elaborated textures, the rigorous forms highlight the essence of the material, the collections explore alternate areas of compatibility to offer turnkey solutions for environments other than the home. Poliform Contract provides a complete response in terms of quality solutions and reliable, accurate services to meet the demands of highly prestigious international projects, giving shape to contemporary experiences and lifestyles.

Affidabilità e servizio.

Non solo estetica. Gli arredi e i sistemi Poliform affiancano a uno stile unico un'affidabilità collaudata nel solco di una qualità totale che non è solo prodotto ma anche servizio. Non solo belli quindi ma duraturi, funzionali, in grado di mantenere inalterate le prestazioni nel tempo, capaci di esprimere il concept di progetto anche attraverso valori che vanno al di là dell'aspetto formale. Dai dettagli agli accessori, dai meccanismi ai sistemi di apertura, dalla qualità dei tessuti alle pelli, capaci di integrare caratteristiche tecniche contemporanee ad un'anima tradizionale. Un risultato, quello della qualità, che si può ottenere unicamente affidandosi a fornitori certificati, con i quali condividere quella ricerca dell'eccellenza che è il motore per migliorare continuamente i propri prodotti e soluzioni. Perché il Made in Italy non si esprima solo in un sistema raffinato ed elegante, perché un servizio di progettazione e post vendita possa garantire affidabilità e sicurezza ed essere un valore fondamentale da evidenziare anche in campo internazionale.

Etica e sostenibilità.

Si parte dalla conoscenza dei materiali e del loro ciclo di vita, si arriva a impianti di energia fotovoltaica che contribuiscono in modo significativo al fabbisogno dei sistemi produttivi. In mezzo c'è una cultura della sostenibilità che parte da lontano, da ogni fase del processo, dal rispetto del territorio e dal dialogo con la comunità di cui l'azienda fa parte. Un'assunzione di responsabilità che si declina nell'impiego di vernici prive di sostanze nocive, che promuove l'impiego di legni provenienti esclusivamente da foreste certificate FSC, che esclude l'impiego di colle negli imballaggi, che promuove il recupero degli scarti di lavorazione a fini energetici. Installazione di tecnologie efficienti dal punto di vista energetico, utilizzo di fonti rinnovabili e controllo di tutto il processo produttivo anche sotto l'aspetto ambientale sono testimonianza di un'attenzione green consolidata e trasversale. Sono però solo alcuni aspetti di un approccio etico complessivo alla responsabilità sociale che è nel dna più profondo di Poliform. Sostenibilità e attenzione all'ambiente in cui l'uomo vive e lavora si esprimono anche nella qualità architettonica dei sette stabilimenti che si inseriscono in maniera armonica e con rispetto nel territorio. L'uomo è al centro di ogni progetto dell'azienda, l'attenzione alle persone l'obiettivo da raggiungere con tutti i sistemi e le collezioni proposte, la diffusione della cultura e della nostra storia l'unica certezza di prolungare nel futuro successi e risultati.

Reliability and service.

More than just a look. Poliform furniture and systems are enhanced by a unique style and tested reliability within a consolidated total quality control system, that isn't just about the product, but also the service. Solutions that don't just look good but which are also lasting and practical, able to guarantee consistent performance, expressing the concept of a project through values that go well beyond the concept of form. From the details to the accessories, from the mechanisms to the opening systems, from the quality of fabrics to the leathers, integrating a series of high-tech features into a traditional soul. A result, the one of quality, that can only be achieved by turning to certified suppliers in pursuit of the same excellence driving the continuous improvement of their own products and solutions. Because Made in Italy is not expressed merely through refined and elegant systems, but also through a design and after-sales service able to guarantee reliability and peace of mind, becoming an essential value also celebrated in an international context.

Ethics and sustainability.

Beginning from a sound knowledge of materials and their lifecycle, right up until the photovoltaic energy systems that significantly contribute to production demands. In between lies a culture of sustainability that begins way back, from every stage of the process, from an inherent respect for the land and continuous dialogue with the community to which the company belongs. An assumption of responsibility expressed through the use of environmentally friendly paints, by promoting the use of wood exclusively from FSC certified forests, by excluding the use of glues in its packaging, and by promoting the recovery of processing waste to be converted into energy. The installation of efficient technology in terms of energy consumption, the use of renewable sources and the monitoring of the entire production process, including environmental aspects, is proof of a consolidated, across-the-board green philosophy. Yet these are just some of the aspects of an all-encompassing ethical approach to social responsibility, which is embedded in Poliform DNA. Sustainability and care for the environment where we live and work are also expressed by the architectural quality of the seven low-impact facilities erected in complete harmony with the surrounding territory. Man is at the centre of every company project, a focus on the individual is the objective sought by all the proposed systems and collections, the diffusion of culture and our story is the only sure way of ensuring continued success and results in the future.

THE NETWORK

Un marchio globale.

Internazionale non solo per gusto, stile e definizione formale, ma anche per diffusione capillare, presenza strategica su tutti i mercati più importanti, penetrazione e distribuzione efficace e puntuale sia sul territorio italiano che all'estero. Sono 86 i paesi nei quali Poliform è presente per un totale di 750 dealers (300 punti vendita italiani a cui si aggiungono 450 punti vendita all'estero), che portano nel mondo il valore di un brand sinonimo di qualità, innovazione e stile, interprete d'eccellenza di un Made in Italy vero, fatto di valori concreti e tangibili ma anche dello straordinario apporto culturale che deriva dalla nostra tradizione produttiva. Poliform associa la capacità di guardare lontano alla consapevolezza di cosa si ha vicino, alimenta l'esplorazione e la continua ricerca di nuove sfide senza perdere di vista il consolidamento e la diffusione della memoria di un territorio, come la Brianza, che ha dato tanto all'azienda in termini di conoscenza, professionalità e passione. Una rete vendita che condivide i valori del brand, le qualità delle proposte, l'ampiezza della gamma e l'infinita possibilità di personalizzazione, per interpretare al meglio ogni esigenza di stile e portare nel mondo collezioni uniche e straordinarie.

Ambasciatori di stile.

Sono i massimi interpreti della qualità Poliform, sono la vetrina privilegiata nelle più importanti metropoli internazionali, sono i migliori diffusori della cultura del progetto dell'azienda, della sua passione e della costante attività di ricerca finalizzata alla qualità dell'abitare. Sono circa 75 gli showroom monobrand Poliform diffusi nel mondo, sono un segnale forte della volontà non solo di esserci, ma anche di esserci in un certo modo, con il proprio stile, le proprie regole, le proprie peculiarità uniche. Spazi progettati per presentare l'ampiezza della gamma, ma anche ideali per incontrare architetti, valutare progetti, suggerire soluzioni. Non solo luoghi di vendita quindi, ma spazi del confronto e dell'analisi, ambienti nei quali si può trovare informazione ma anche formazione, non solo prodotti ma soprattutto progetti. Gli showroom sono molto diversi fra loro, le proposte abitative nei diversi paesi riflettono gli apporti e le influenze di culture molto distanti, ma tutte le soluzioni hanno nella qualità il proprio fattore comune, nella coerenza di Poliform la garanzia di esclusività.

A global brand.

International not only for its look, style and formal definition, but also thanks to its capillary networks, its strategic presence in all the most important markets, its efficient and accurate penetration and distribution in both Italian and foreign territories. The Poliform network spans across 86 countries with a total of 750 dealers (300 Italian stores plus another 450 foreign points of sale), bringing to the world the value of a brand synonymous with quality, innovation and style, interpreting the excellence of the genuine Made in Italy brand, consisting in real and tangible values but also the extraordinary cultural contribution of our manufacturing tradition. Poliform combines the ability to look beyond with an awareness of that which is near, encouraging exploration and the continuous search for new challenges without ever losing sight of the consolidation and promotion of a territory filled with history, such as Brianza, which has given much to the company in terms of knowledge, professionalism and passion. A sales network that shares the values of a brand, the qualities of an offer, the broadness of a range and infinite possibilities for personalisation, to best interpret all stylistic needs and introduce the world to unique and extraordinary collections.

Ambassadors of style.

The highest interpreters of Poliform quality, the privileged showcases in the most important international metropolises, the best advocates of the company's project culture, its passion and constant research geared towards quality living. They are the more or less 75 single-brand Poliform showrooms distributed worldwide, a strong sign of the desire not only to be, but also to be in a certain way, with one's own style, one's own rules, one's own unique features. Spaces designed to portray the extent of the range, while perfect for meeting architects, evaluating projects, suggesting solutions. Not only sales floors, but spaces for comparison and analysis, places where information can be found, but also where products and projects take shape. The showrooms are very different to each other, with home interior proposals reflecting each country's extremely varied local customs and cultural influences, but all solutions share the same high quality and Poliform's reliable guarantee of exclusivity.

THE COMPANY

SEVEN UNITS

FACTORY 1
POLIFORM HEADQUARTERS
Inverigo:
day systems
management
sales
r&d
administration
finance office
technical office

FACTORY 2
POLIFORM
Arosio:
wardrobes - walk-in closets

FACTORY 3
POLIFORM SOFAS
Inverigo:
sofas & armchairs

FACTORY 4
POLIFORM
Mirovano:
day complements

FACTORY 5
VARENNA HEADQUARTERS
Lurago d'Erba:
kitchen division
sales
r&d
technical office

FACTORY 6
POLIFORM | LAB
Inverigo:
company showroom
marketing & communication
project department
styling department
photo studio

FACTORY 7
POLIFORM CONTRACT
Inverigo:
contract division

DEALERS POLIFORM AND VARENNA IN THE WORLD

Albania	Hong Kong	Montenegro	Switzerland
Andorra	Hungary	Morocco	Taiwan
Arabia Saudita	India	Netherlands	Thailand
Australia	Indonesia	New Caledonia	Tunisia
Austria	Iran	New Zealand	Turkey
Azerbaijan	Israel	Nigeria	Ukraine
Bahrain	Italy	Norway	United Arab Emirates
Belgium	Japan	Panama	United Kingdom
Bosnia	Jordan	Perù	United States
Brazil	Kazakhstan	Philippines	Uruguay
Bulgaria	Korea	Poland	Venezuela
Canada	Kuwait	Portugal	Vietnam
China	Latvia	Puerto Rico	
Croatia	Lebanon	Qatar	
Cyprus	Libya	Romania	
Czech Republic	Liechtenstein	Russia	
Denmark	Lithuania	Saudi Arabia	
Dominican Republic	Luxembourg	Senegal	
Egypt	Macedonia	Serbia	
Estonia	Malaysia	Singapore	
Finland	Malta	Slovakia	
France	Mexico	Slovenia	
Georgia	Moldova	South Africa	
Germany	Monaco	Spain	
Greece	Mongolia	Sweden	

WHEN THE COMFORT
OF INTIMACY
MEETS THE CLEARNESS
OF TRANSPARENCY

In questo progetto: letto, comodini e cassetiera Kelly. Armadi Senzafine Bangkok con Quid integrato, armadio vetrina Ego. Divano, poltrone e panca Jane, madia Quid. Scrivitoio Mathieu, sedia Sophie.

This project: bed, night tables and chest of drawers Kelly. Senzafine Bangkok wardrobes with integrated Quid, showcase wardrobe Ego. Jane sofa, armchairs and bench, Quid sideboard. Mathieu desk, Sophie chair.





In questa pagina: armadi Senzafine Bangkok apertura battente, ante in cuoio 28 avorio con profili maniglie brown nickel lucido. Quid integrato con pannelli boiserie olmo nero, bacheche laccato opaco piombo con ripiani vetro trasparente e cassetti cuoio 28 avorio con maniglie brown nickel opaco, illuminazione led dimmerabile. Letto Kelly con rivestimento esterno testata, rulli e interno giroletto in pelle Nabuk 02 tortora, interno testata pelle Nabuk intrecciata 02 tortora, giroletto rovere spessart. Coordinato letto Provence 08 polvere, profili bianco e polvere. Comodino Kelly rovere spessart con top laccato lucido caramello e piedini brown nickel lucido. Poltrona e panca Jane in tessuto sfoderabile Paros 6 arena, gambe brown nickel lucido.

This page: Senzafine Bangkok wardrobes with leaf doors in hide 28 avorio with glossy brown nickel handle profiles. Integrated Quid composition with wall panelling in black elm, piombo mat lacquered open cases with transparent glass shelves and drawers in hide 28 avorio with mat brown nickel handles, led lighting with dimmer. Kelly bed with headboard external covering, roll cushions and bedframe interior in leather Nabuk 02 tortora, headboard inner covering in woven leather Nabuk 02 tortora, bedframe in spessart oak. Bed-set Provence 08 polvere, piping bianco and polvere. Kelly night table in spessart oak with caramello glossy lacquered top and glossy brown nickel feet. Jane armchair and bench in removable fabric Paros 6 arena, glossy brown nickel legs.

In questa pagina e nella successiva: letto Kelly con rivestimento esterno testata, rulli e interno giroletto in pelle Nabuk 02 tortora, interno testata pelle Nabuk intrecciata 02 tortora, giroletto rovere spessart. Coordinato letto Provence 08 polvere, profili bianco e polvere. Comodino Kelly rovere spessart con top laccato lucido caramello e piedini brown nickel lucido. Poltrona e panca Jane in tessuto sfoderabile Paros 6 arena, gambe brown nickel lucido.

This and next page : Kelly bed with headboard external covering, roll cushions and bedframe interior in leather Nabuk 02 tortora, headboard inner covering in woven leather Nabuk 02 tortora, bedframe in spessart oak. Bed-set Provence 08 polvere, piping bianco and polvere. Kelly night table in spessart oak with caramello glossy lacquered top and glossy brown nickel feet. Jane bench and armchair in removable fabric Paros 6 arena, glossy brown nickel legs.







In questa pagina: cassettera Kelly rovere spessart con top cuoio 29 tortora e piedini brown nickel lucido.
Pouf Gant rivestimento pelle Soft 14 oliva.



This page: Kelly chest of drawers in spessart oak with top in hide 29 tortora and glossy brown nickel feet.
Gant pouf covered in leather Soft 14 oliva.





In questa pagina e nella precedente: divano e poltrone Jane in tessuto sfoderabile Skyros 2 oliva, gambe brown nickel lucido. Tavolino Tridente piano in marmo lucido noir saint laurent, cornice e struttura olmo nero. Pouf Gant in pelle Soft 14 oliva. Madia Quid con cassetti e fianchi laterali laccato lucido canapa, top in marmo lucido calacatta oro, profilo maniglie brown nickel lucido.

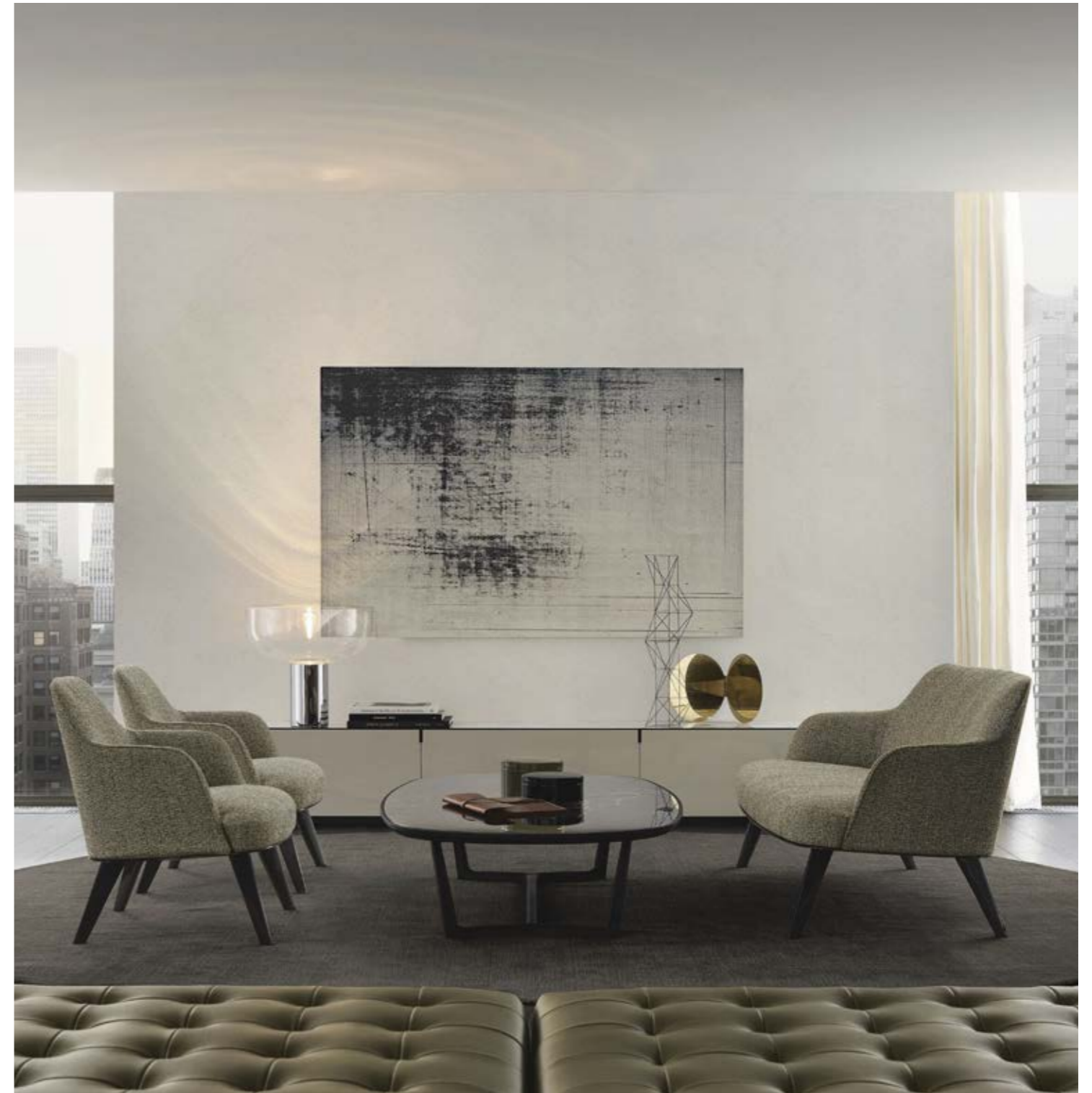

This and previous page: Jane sofa and armchairs in removable fabric Skyros 2 oliva, glossy brown nickel legs. Tridente coffee table with top in glossy marble noir saint laurent, frame and structure in black elm. Gant pouf in leather Soft 14 oliva. Quid sideboard with canapa glossy lacquered drawers and exposed sides, top in glossy marble calacatta oro, handle profiles in glossy brown nickel.

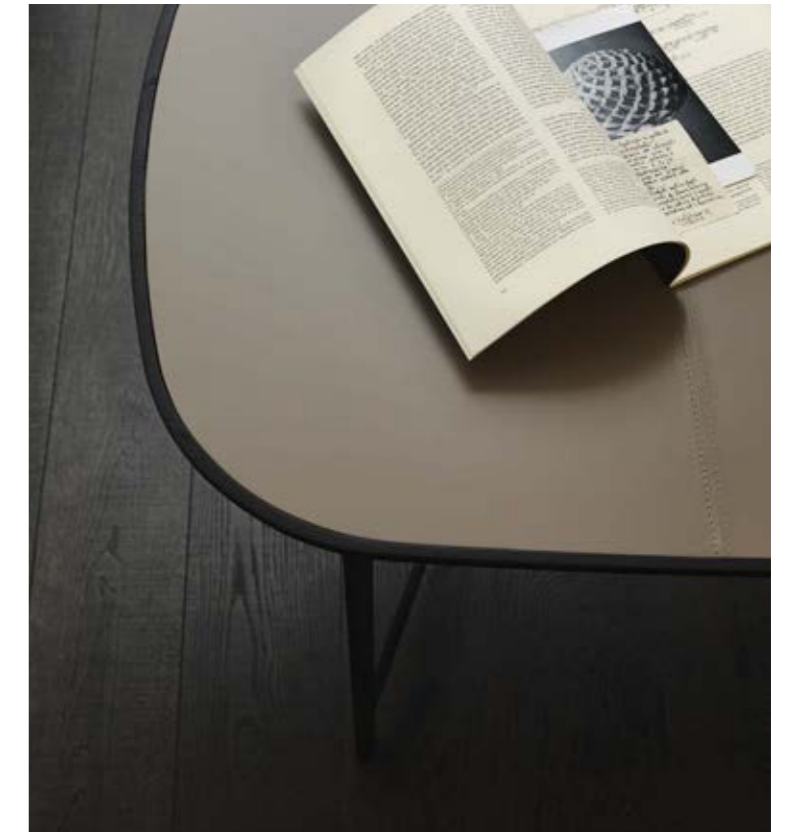

In questa pagina: scrittoio Mathieu struttura brown nickel lucido, piano con cornice rovere spessart e inserto in cuoio 29 tortora. Sedia Sophie con bracciolo in pelle Soft 14 oliva e gambe olmo nero.
This page: Mathieu desk with structure in glossy brown nickel, top with frame in spessart oak and insert in hide 29 tortora. Sophie chair with armrest in leather Soft 14 oliva and black elm legs.

In questa pagina: armadio Senzafine Ego apertura battente, con ante vetro trasparente riflettente e telaio verniciato opaco piombo, fianchi laterali e schienali in vetro trasparente riflettente. Armadi Senzafine Bangkok apertura battente, ante in cuoio 26 invecchiato con profili maniglie brown nickel lucido. Poltrona Jane in tessuto sfoderabile Paros 6 arena, gambe brown nickel lucido. Pouf Onda in tessuto sfoderabile Skyros 1 nero.

This page: Senzafine Ego wardrobe with leaf doors in transparent reflecting glass and piombo mat lacquered frame, lateral sides and backs in transparent reflecting glass. Wardrobe Senzafine Bangkok with leaf doors in hide 26 invecchiato with handle profiles in glossy brown nickel. Jane armchair in removable fabric Paros 6 arena, glossy brown nickel legs. Onda pouf in removable fabric Skyros 1 nero.

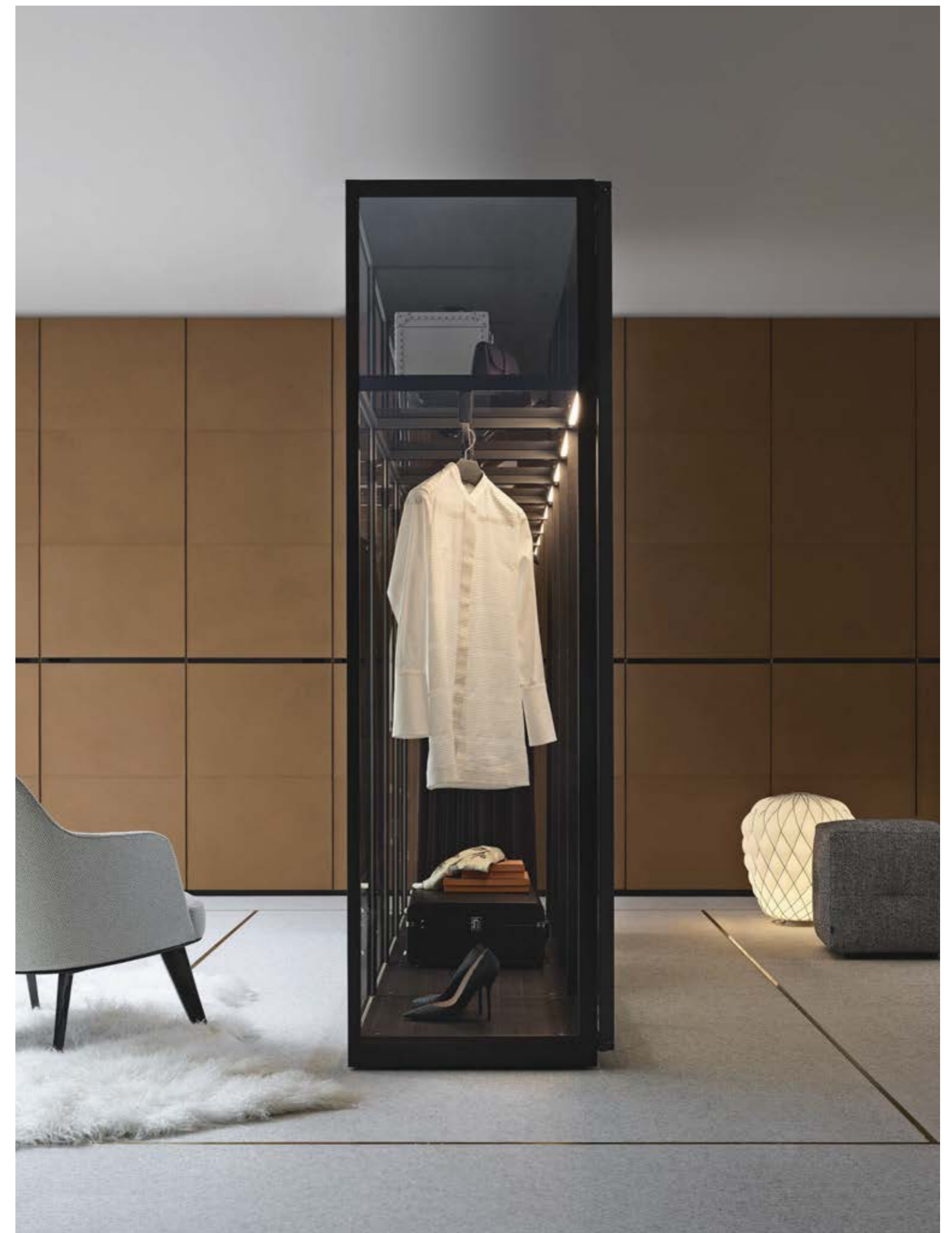





In questa pagina e nella precedente: armadi Senzafine Bangkok apertura battente, ante in cuoio 26 invecchiato con profili maniglie brown nickel lucido. Quid integrato con pannelli boiserie olmo nero, bacheche laccato opaco piombo con ripiani vetro trasparente e cassetti in olmo nero con maniglie brown nickel opaco, illuminazione led dimmerabile. Armadio Senzafine Ego apertura battente, con ante vetro trasparente riflettente e telaio verniciato opaco piombo, fianchi laterali e schienali in vetro trasparente riflettente. Poltrone Jane in tessuto sfoderabile Paros 6 arena, gambe brown nickel lucido.



This and previous page: Senzafine Bangkok wardrobes with leaf opening, doors in hide 26 invecchiato with glossy brown nickel handle profiles. Integrated Quid compositions with black elm wall panelling, piombo mat lacquered open cases with transparent glass shelves and black elm drawers with mat brown nickel handles, led lighting with dimmer. Senzafine Ego wardrobe with leaf opening, glass doors in transparent reflecting glass and piombo mat lacquered frame, lateral sides and backs in transparent reflecting glass. Jane armchair in removable fabric Paros 6 arena, glossy brown nickel legs.

In questa pagina: Quid vanity integrato con pannelli boiserie olmo nero e specchio con mensoline laccato opaco carbone, mensola olmo nero con bacheche laccato opaco piombo, ante ribalta cuoio 02 nero, ripiani vetro trasparente, illuminazione led dimmerabile. Pouf Onda in pelle Soft 2 mastice. Armadi Senzafine Bangkok apertura battente, ante in cuoio 26 invecchiato con profili maniglie brown nickel lucido.

This page: integrated Quid vanity with wall panelling in black elm and mirror with carbone mat lacquered shelves, black elm big shelf with piombo mat lacquered open display cases, flap doors in hide 02 nero, shelves in transparent glass, led lighting with dimmer. Onda pouf in leather Soft 2 mastice. Wardrobes Senzafine Bangkok with leaf opening, doors in hide 26 invecchiato with handle profiles in glossy brown nickel.



Bangkok A armadi h 2590 p 609
 ante: apertura battente
 finitura: cuoio 28 avorio, profili maniglie brown nickel lucido
 fianchi laterali: laccato opaco piombo
 interni: nobilitato rovere spessart

Quid A integrato
 pannelli boiserie l 900, finitura olmo nero
 bacheche laccato opaco piombo, cassetti cuoio 28 avorio, maniglie brown nickel opaco, ripiani vetro trasparente, illuminazione led dimmerabile

Ego h 2270 p 609
 ante: apertura battente
 finitura: vetro trasparente riflettente con telaio e maniglie integrate verniciato opaco piombo
 fianchi laterali e schienali: vetro trasparente riflettente
 interni e fianchi telaio: nobilitato rovere spessart

Bangkok B armadi h 2590 p 609
 ante: apertura battente
 finitura: cuoio 26 invecchiato, profili maniglie brown nickel lucido
 fianchi laterali: laccato opaco piombo
 interni: nobilitato rovere spessart

Quid B integrato
 pannelli boiserie l 1200, finitura olmo nero
 bacheche laccato opaco piombo, maniglie brown nickel opaco, cassetti olmo nero, ripiani vetro trasparente, illuminazione led dimmerabile

Quid B vanity integrato
 pannelli boiserie l 1200, finitura olmo nero e specchio con mensole laccato opaco carbone, mensolone olmo nero, bacheche laccato opaco piombo con ante ribalta cuoio 02 nero, ripiani vetro trasparente, illuminazione led dimmerabile

Bangkok A wardrobes h 102" d 24"
 doors: leaf opening
 finishing: hide 28 avorio, handle profiles glossy brown nickel
 lateral sides: mat lacquered piombo
 interiors: spessart oak melamine

Quid A integrated
 wall panelling w 35 1/2", black elm finishing
 piombo mat lacquered open cases, hide drawers 28 avorio, mat brown nickel handles, transparent glass shelves, led lighting with dimmer

Ego h 89 1/4" d 24"
 doors: leaf opening
 finishing: transparent reflecting glass with piombo mat lacquered frame and integrated handle
 lateral sides and backs: transparent reflecting glass
 interiors and frame sides: spessart oak melamine

Bangkok B wardrobes h 102" d 24"
 doors: leaf opening
 finishing: hide 26 invecchiato, handle profiles glossy brown nickel
 lateral sides: mat lacquered piombo
 interiors: spessart oak melamine

Quid B integrated
 wall panelling w 47 1/4", black elm finishing, piombo mat lacquered open cases, mat brown nickel handles, black elm drawers, transparent glass shelves, led lighting with dimmer

Quid B integrated vanity
 wall panelling w 47 1/4", black elm finishing and mirror with carbone mat lacquered shelves, big shelf in black elm, piombo mat lacquered open cases with flap doors in hide 02 nero, transparent glass shelves, led lighting with dimmer

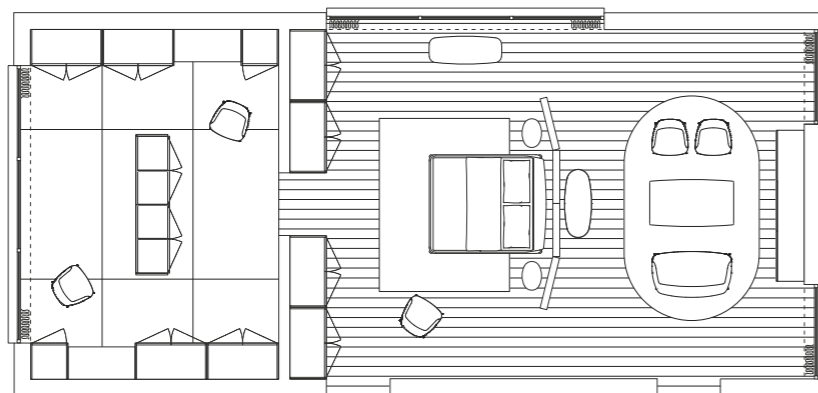

Bangkok armadi/wardrobes design Operadesign - Quid design CR&S Poliform

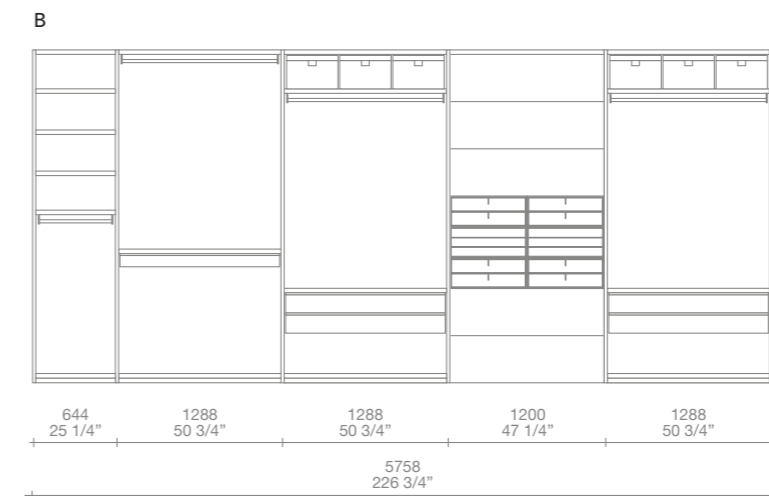
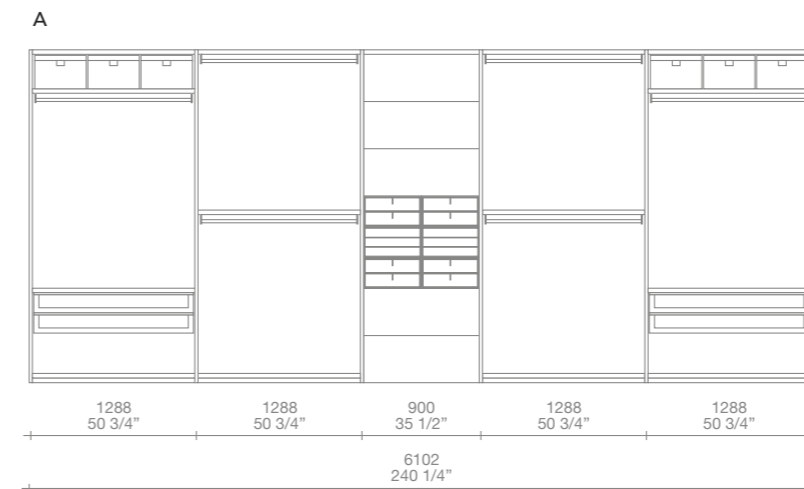

Ego armadi/wardrobes design Giuseppe Bavuso

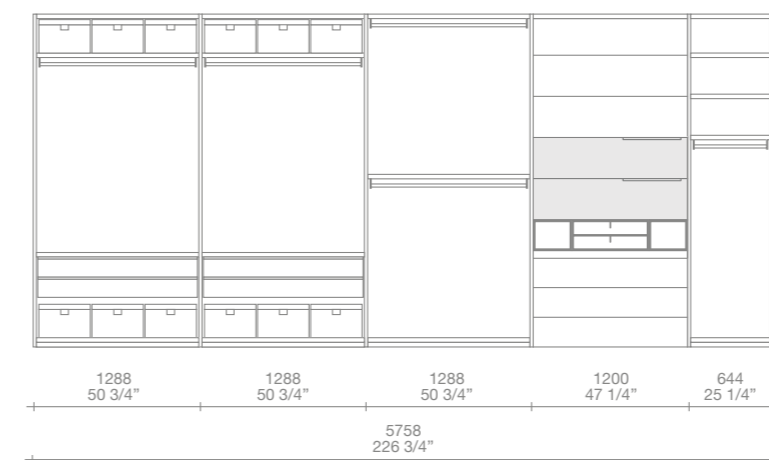
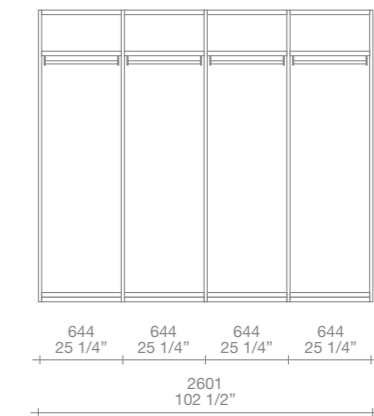

Kelly letto
testata esterna, interno giroletto e rulli in pelle Nabuk 02 tortora
testata interna pelle Nabuk intrecciata 02 tortora, giroletto in rovere spessart

Kelly comodino
rovere spessart, top laccato lucido caramello, piedini brown nickel lucido

Jane panca
tessuto sfoderabile Paros 6 arena, gambe brown nickel lucido

Jane poltrona
tessuto sfoderabile Paros 6 arena, gambe brown nickel lucido

Kelly cassetiera
rovere spessart, top cuoio 29 tortora, gambe brown nickel lucido

Jane divano e poltrona
tessuto sfoderabile Skyros 2 oliva, gambe brown nickel lucido

Tridente tavolino
struttura olmo nero, piano marmo lucido noir saint laurent e cornice olmo nero

Gant pouf
pelle Soft 14 oliva

Quid madia
contenitori a terra con cassetti e fianchi laterali laccato lucido canapa
maniglie profili brown nickel lucido
top marmo lucido calacatta oro

Mathieu scrittoio
struttura brown nickel lucido, piano cornice rovere spessart e inserto cuoio 29 tortora

Sophie sedia
pelle Soft 14 oliva, gambe olmo nero

Onda pouf
tessuto sfoderabile Skyros 1 nero e in pelle Soft 2 mastice

Kelly bed
external headboard covering, bed frame interior and roll cushions in leather Nabuk 02 tortora
headboard inner covering in woven leather Nabuk 02 tortora, bed frame in spessart oak

Kelly night table
in spessart oak, caramello glossy lacquered top, glossy brown nickel feet

Jane bench
removable fabric Paros 6 arena, glossy brown nickel legs

Jane armchair
removable fabric Paros 6 arena, glossy brown nickel legs

Kelly chest of drawers
in spessart oak, top in hide 29 tortora, glossy brown nickel legs

Jane sofa and armchair
removable fabric Skyros 2 oliva, glossy brown nickel legs

Tridente coffee table
black elm structure, top in glossy noir saint laurent marble and black elm frame

Gant pouf
leather Soft 14 oliva

Quid sideboard
floor standing units with canapa glossy lacquered drawers and lateral sides
handle profiles and plinth in mat brown nickel
top in glossy calacatta oro marble

Mathieu desk
glossy brown nickel structure, top with frame in spessart oak and insert in hide 29 tortora

Sophie chair
in leather Soft 14 oliva, black elm legs

Onda pouf
in removable fabric Skyros 1 nero and in leather Soft 2 mastice

Kelly design Emmanuel Gallina

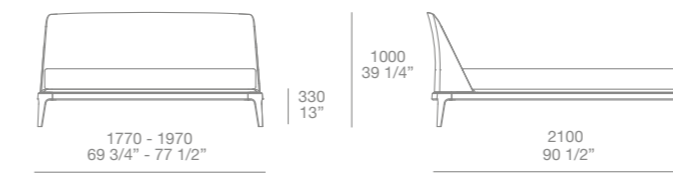

Jane design Emmanuel Gallina

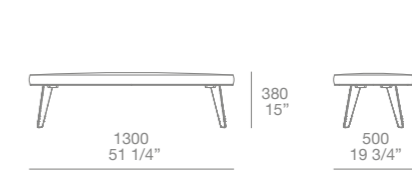

Kelly design Emmanuel Gallina

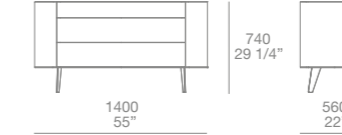
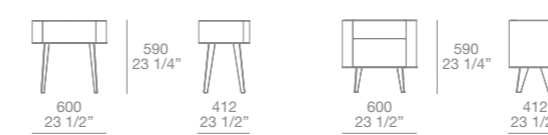

Quid design CR&S Poliform

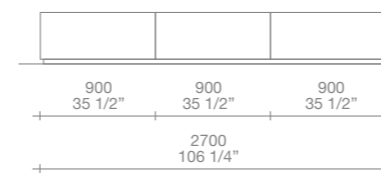

Tridente design Roberto Barbieri



Jane design Emmanuel Gallina

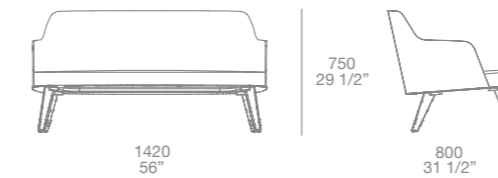

Jane design Emmanuel Gallina

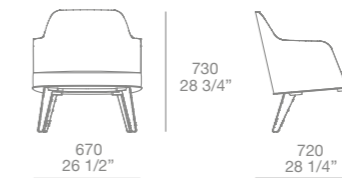

Mathieu design Emmanuel Gallina

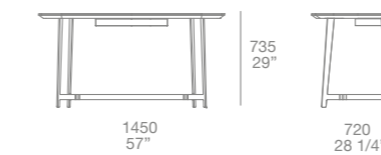

Sophie design Emmanuel Gallina



Onda design CR&S Poliform

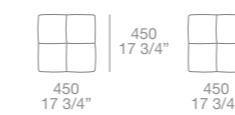

Gant design CR&S Poliform

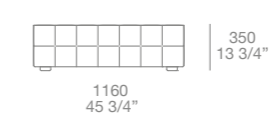

DELICATE CHROMATIC
BALANCES, ESSENTIAL
LINES AND REFINED
TEXTURES

In questo progetto: letto Rever base e testata con rivestimento in tessuto sfoderabile Orleans 5 pernice e pelle Nabuk 1 latte. Armadi Senzafine Skin apertura complanare, ante nobilitato Skin laccato opaco latte. Cabina armadio Ubik con pannelli a parete nobilitato Skin laccato opaco latte, attrezzature nobilitato rovere cenere.

This project: Rever bed with upholstered frame and headboard with removable fabric covering Orleans 5 pernice and Nabuk leather 1 latte. Wardrobes Senzafine Skin with coplanar opening, latte mat lacquered Skin melamine doors. Ubik walk-in closet with wall mounted panels in latte mat lacquered Skin melamine, equipment in cenere oak melamine.









Nelle pagine precedenti e in questa: letto Rever, rivestimento in tessuto sfoderabile Orlean 5 pernice e pelle Nabuk 1 latte. Coordinato letto Provence 01 bianco e 08 polvere profilo nero. Tavolino Soori bronzo anticato. Panca Home Hotel Collection in olmo nero con cuscino sfoderabile pelle Nabuk 2 tortora.



Previous pages and this page: Rever bed covered in removable fabric Orleans 5 pernice and Nabuk leather 1 latte. Bed linen Provence 01 bianco and 08 polvere with black profile. Soori small table in antique bronze. Home Hotel Collection bench in black elm with cushion in removable Nabuk leather 2 tortora.



Nella pagina precedente: mensolone sospeso Quid piano e schienale in olmo nero, bacheca laccato opaco piombo con cassetti cuoio 26 invecchiato. Ripiani vetro trasparente e illuminazione led integrata. Pouf Onda rivestito in pelle sfoderabile Nabuk 1 latte. In questa pagina e nella successiva: ripiani portascarpe nobilitato rovere cenere. Cabina armadio Ubik con pannelli a parete nobilitato Skin laccato opaco latte, attrezzatura nobilitato rovere cenere. Armadi Skin apertura complanare, ante nobilitato Skin laccato opaco latte. Panca Home Hotel collection in olmo nero con cuscino sfoderabile Nabuk 2 tortora. Poltrona Mad Chair in tessuto sfoderabile Limoges 3 quarzo e gambe in olmo nero.

Previous page: Quid wall mounted shelf, top and back in black elm, piombo mat lacquered open compartments with hide drawers 26 invecchiato. Transparent glass shelves with integrated led light. Onda pouf covered in removable Nabuk leather 1 latte. This page and next page: shoe shelves in cenere oak melamine. Ubik walk-in closet with wall mounted panels in latte mat lacquered Skin melamine. Home Hotel Collection bench in black elm with removable leather Nabuk covered cushion 2 tortora. Mad Chair armchair with removable fabric Limoges 3 quarzo and legs in black elm.







In questa pagina: interni armadio Skin in nobilitato rovere cenere con ripiani rivestiti in tecnopelle 05 latte e telaio verniciato piombo. Nella foto in alto: maniglia Gap laccato opaco piombo con fondo rivestimento in tecnopelle 05 latte.

This page: Skin wardrobe interiors in cenere oak melamine with techno-leather covered shelves 05 latte and piombo painted metal frame. Above: piombo mat lacquered Gap handle with techno-leather 05 latte covered bottom.







Nella pagina precedente: cabina armadio Ubik con pannelli a parete nobilitato Skin laccato opaco latte, attrezzatura nobilitato rovere cenere. Armadi Skin apertura complanare, ante nobilitato Skin laccato opaco latte. Panca Home Hotel Collection in olmo nero con cuscino sfoderabile Nabuk 2 tortora. Poltrona Mad Chair in tessuto sfoderabile Limoges 3 quarzo e gambe in olmo nero. In questa pagina: cassettiere nobilitato rovere cenere con coperchio in tecnopelle 05 latte e telaio verniciato piombo , ripiani in vetro fumè con telaio verniciato piombo.

Previous page: Ubik walk-in closet with wall mounted panels in latte mat lacquered Skin melamine, melamine cenere oak equipment. Wardrobes Skin with coplanar opening, latte mat lacquered Skin melamine doors. Home Hotel Collection bench in black elm with cushion in removable Nabuk leather 2 tortora. Mad Chair armchair with removable fabric Limoges 3 quarzo and legs in black elm. This page: melamine cenere oak chests of drawers with techno-leather top 05 latte and piombo painted metal frame, fume glass shelves with piombo painted metal frame.



In questa pagina: ripiani portascarpe nobilitato rovere cenere e profili battitacco in alluminio verniciato piombo. Cabina armadio Ubik con pannelli a parete nobilitato Skin laccato opaco latte, attrezzature nobilitato rovere cenere. Armadio Skin apertura complanare, ante nobilitato Skin laccato opaco latte e maniglie Gap laccato opaco piombo. Panca Home Hotel Collection in olmo nero con cuscino sfoderabile pelle Nabuk 2 tortora.

This page: inclined shoe shelves in cenere oak melamine with frames in piombo painted aluminium. Ubik walk-in closet with wall-mounted panels in latte mat lacquered Skin melamine, equipment in cenere oak melamine. Skin wardrobe with coplanar opening, latte mat lacquered Skin melamine doors with piombo mat lacquered Gap handles. Home Hotel Collection bench in black elm with cushion in removable Nabuk leather 2 tortora.

Ubik cabina armadio h 2590
 finitura pannelli: nobilitato Skin laccato opaco 94 latte
 attrezzatura: nobilitato rovere cenere, tecnopelle 05 latte, verniciato piombo

Skin armadi h 2590 p 609
 ante: Skin apertura complanare
 finitura: nobilitato Skin laccato opaco 94 latte, maniglia Gap laccato opaco piombo con fondo rivestito in tecnopelle 05 latte
 interni: nobilitato rovere cenere, tecnopelle 05 latte, verniciato piombo

Ubik walk-in closet h 102"
 panels finishing: 94 latte mat lacquered Skin melamine
 equipment: cenere oak melamine, 05 latte techno-leather, piombo painted

Skin wardrobes h 102" d 24"
 doors: Skin coplanar doors opening
 finishing: 94 latte mat lacquered Skin melamine, piombo mat lacquered Gap handle with 05 latte techno-leather covered bottom
 inner equipment: cenere oak melamine, 05 latte techno-leather, piombo painted metal

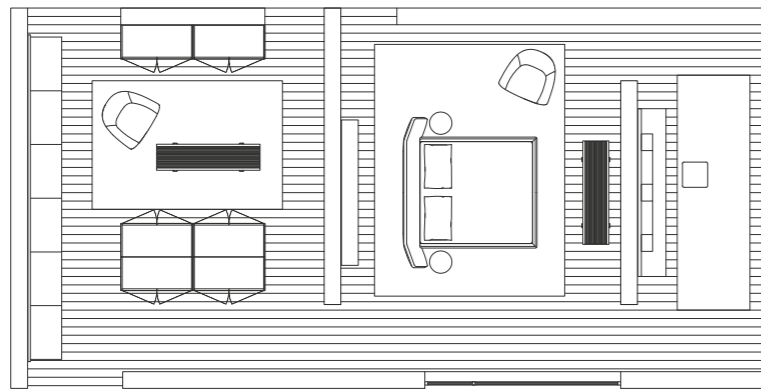

Ubik cabina armadio/walk-in closet design CR&S Poliform



Skin armadi/wardrobes design CR&S Poliform

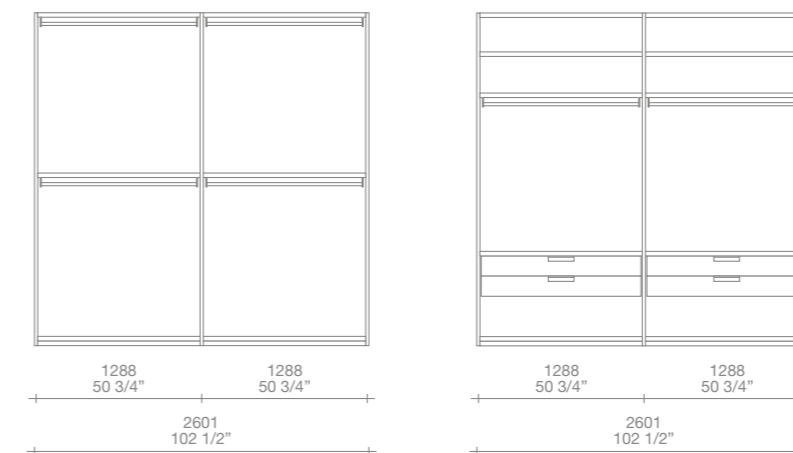

Rever letto
tessuto sfoderabile Orleans 5 pernice
e pelle Nabuk 1 latte,
rulli pelle sfoderabile Nabuk 1 latte

Soori tavolino
finitura bronzo anticato

Home Hotel Collection
panca in olmo nero, cuscino pelle sfoderabile
Nabuk 2 tortora

Mad Chair poltrona
tessuto sfoderabile Limoges 3 quarzo,
gambe olmo nero

Quid h 360 p 200-600
mensole sospeso sp 60, schienale h 300
finitura olmo nero
bacheca h 300 laccato opaco piombo
con cassetti cuoio 26 invecchiato
e ripiani vetro trasparente, illuminazione led
integrata

Onda pouf
pelle sfoderabile Nabuk 1 latte

Rever bed
removable fabric Orleans 5 pernice and Nabuk
leather 1 latte, roll-cushions in removable Nabuk
leather 1 latte

Soori table
antique bronze finishing

Home Hotel Collection
bench in black elm, cushion in removable Nabuk
leather 2 tortora

Mad Chair armchair
removable fabric Limoges 3 quarzo,
legs in black elm

Quid h 14 1/4" d 7 3/4"- 23 1/2"
hanging shelf thickness 2 1/4", back h 11 3/4"
in black elm
open compartment h 11 3/4" in piombo mat
lacquer with drawers in hide 26 invecchiato and
shelves in transparent glass with integrated led
light

Onda pouf
removable Nabuk leather 1 latte

Rever design Rodolfo Dordoni

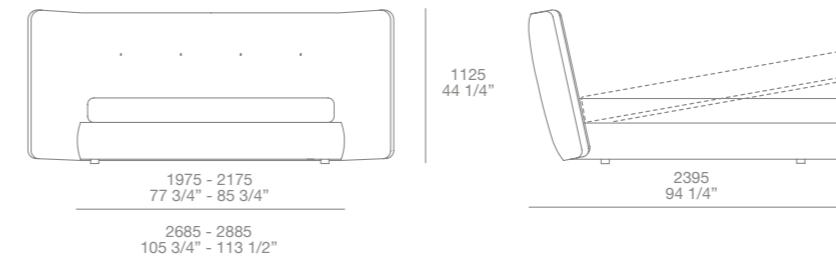

Soori design Soo Chan



Home Hotel Collection design Jean-Marie Massaud

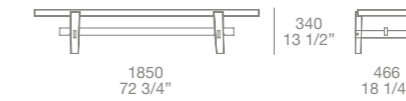

Onda design CR&S Poliform



Mad Chair design Marcel Wanders

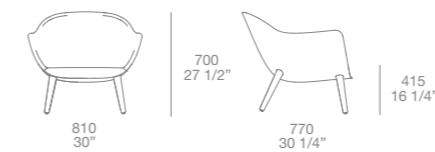

Quid composizione/composition design CR&S Poliform

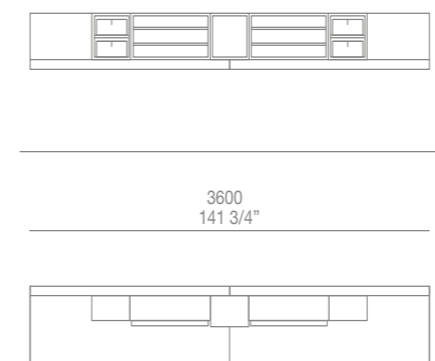

WHEN PRIVATE SPACES EVOLVE INTO A BOLD AND FUNCTIONAL SHOWPIECE

In questo progetto: boiserie e letto Dream in velluto Persia 1404 carbone e pelle Special 40 ardesia, mensole laccato lucido visone. Armadi Senzafine New Entry battente, ante laccato lucido moka, maniglie Volo. Cabina armadio Senzafine nobilitato rovere cenere. Letto Jacqueline in tessuto sfoderabile Lima 43 ecrù.

This project: Dream bed and wall panelling in 1404 carbone Persia velvet and 40 ardesia Special leather, shelves visone glossy lacquered. Senzafine New Entry wardrobes, leaf opening, moka glossy lacquered doors, Volo handles. Senzafine walk-in closet in cenere oak melamine. Jacqueline bed in 43 ecrù Lima removable fabric.







Nella pagina precedente e in questa: boiserie imbottita e rivestita in velluto sfoderabile Persia 1404 carbone, testata centrale e giroletto rivestimento in pelle sfoderabile Special 40 ardesia. Coordinato letto Provence 01 bianco e 05 agave profilo nero. Comodini Dream laccato lucido moka. Poltrone Gaston struttura nero lucido, cuscini seduta e schienale rivestiti in pelle Super 7 nero.

Previous and this page: Wall panelling upholstered and covered in 1404 carbone Persia removable velvet, central wall panelling and base in 40 ardesia Special removable leather. Bed-set in 01 bianco and 05 agave Provence with black piping stitching style. Dream night tables moka glossy lacquered. Gaston armchairs with black metal painted structure, seat and back cushions covered in 07 nero Super leather.



In questa pagina: poltrona Gaston seduta e braccioli rivestimento in pelle Super 7 nero, struttura metallo verniciato nero lucido. A destra: dettaglio del bracciolo. Disponibile anche con rivestimento in tessuto, la poltrona Gaston è una proposta in grado di completare differenti interpretazioni stilistiche della zona living.

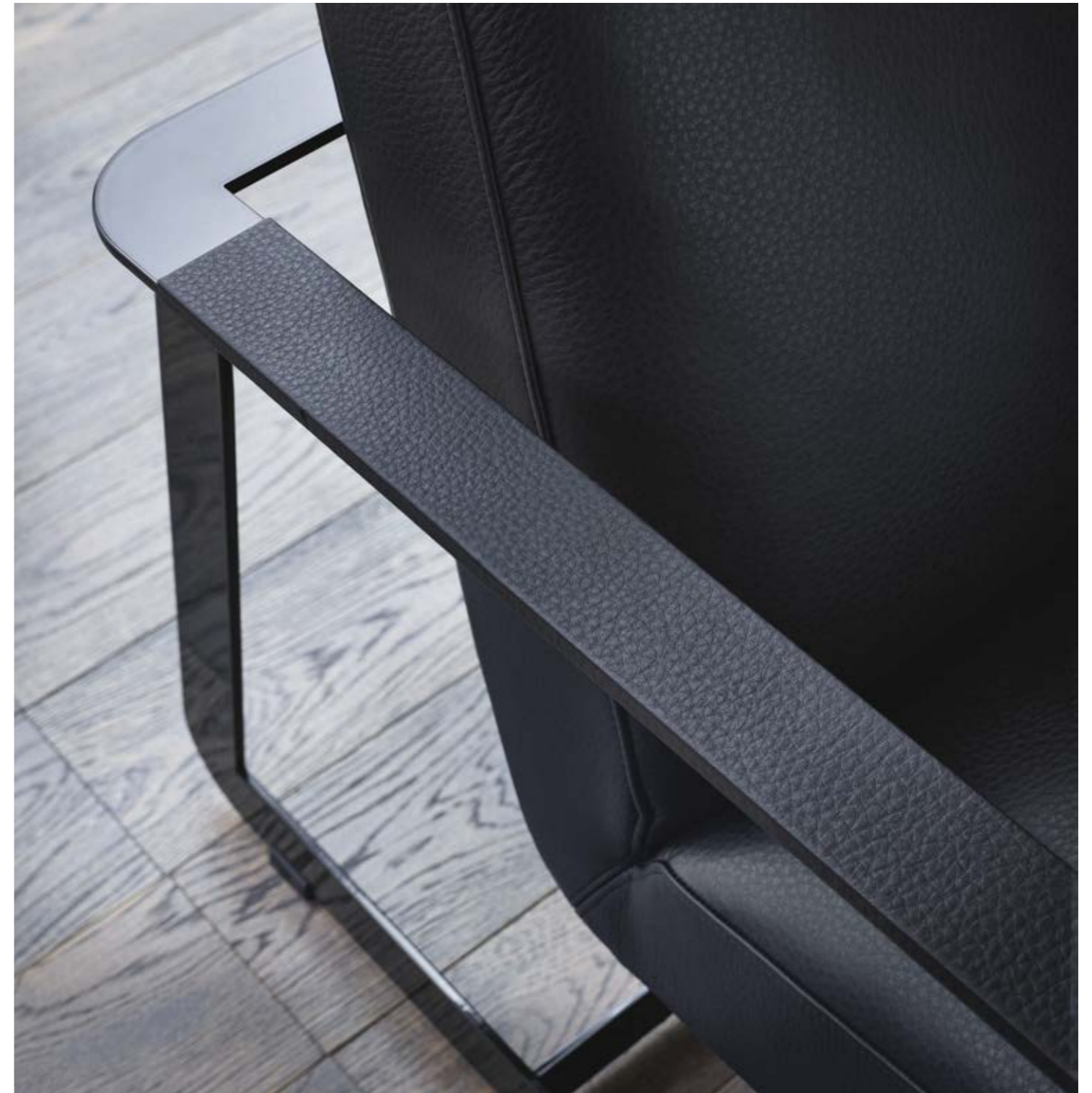

This page: Gaston armchair with seat and armrest covering in 07 nero Super leather, black glossy metal painted structure. Above: arm detail. Gaston armchair, available also with fabric covering, is a proposal that completes the living area enabling several different styles.

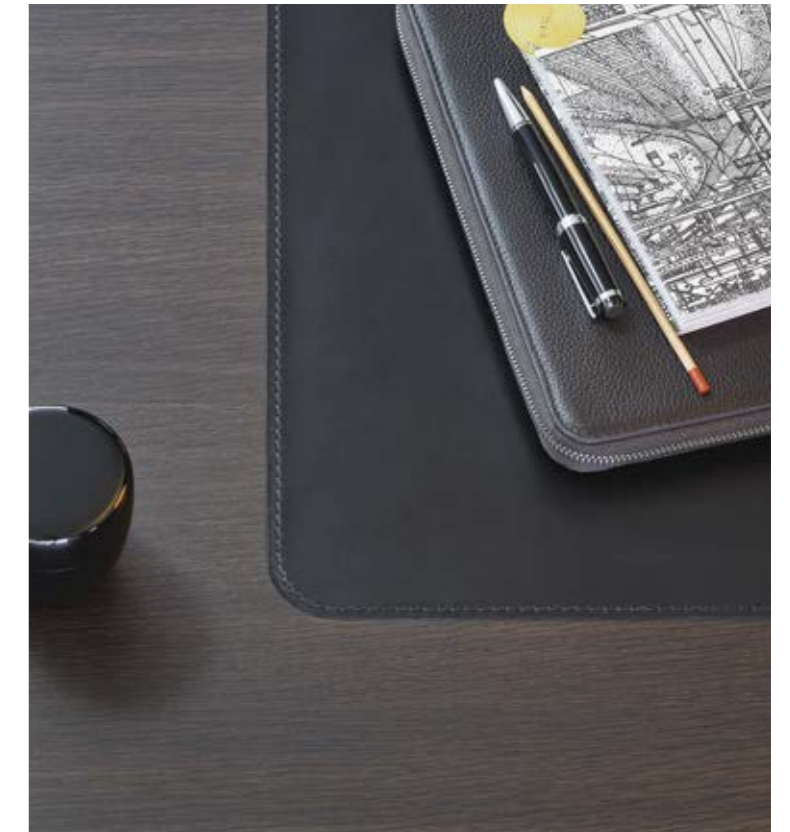

In questa pagina: scrittoio Concorde rovere spessart, sottomano in cuoio. Sedia Manta rivestita in pelle Vintage 96 nero. Pouf Onda rivestito in velluto Persia 1401 oliva. Boiserie sistema Dream velluto Persia 1404 carbone, mensole laccato lucido visone.

This page: Concorde writing desk in Spessart oak with hide pad. Manta chair covered in 96 black Vintage leather. Onda pouf covered in 1401 oliva Persia velvet. Dream wall panelling in 1404 carbone Persia velvet, shelves in visone glossy lacquered.



Nella foto in alto: cabina armadio Senzafine nobilitato rovere cenere. Pouf Gant rivestimento in pelle Nabuk 1 latte. Tavolino Tribeca verniciato brown nickel opaco e piano in marmo emperador dark lucido. Boiserie sistema Dream in velluto Persia 1404 carbone, mensole laccato lucido visone. Nella pagina a destra: armadi Senzafine New Entry battente, ante laccato lucido moka, maniglie Volo.

Above: Senzafine walk-in closet in cenere oak melamine. Gant pouf in 01 latte Nabuk leather. Tribeca coffee table mat brown nickel painted and glossy emperador Dark marble top. Dream wall panelling in 1404 carbone Persia velvet, shelves in visone glossy lacquered. To the right: Senzafine New Entry wardrobes, leaf opening, moka glossy lacquered doors, Volo handles.





Nella pagina precedente: cabina armadio Senzafine nobilitato rovere cenere. In questa pagina: cassettiere nobilitato rovere cenere con maniglia Gap verniciato piombo con inserto in tecnopelle 01 visone, ripiani in vetro fumé con telaio verniciato piombo. Svuotatasche estraibili laccato opaco piombo, vaschette, porta orologi e porta gioielli con struttura rivestita in pelle e interni in seta.

Previous page: Senzafine walk-in closet in cenere oak melamine. This page: chest of drawers in cenere oak melamine with piombo painted Gap handle and 01 visone techno-leather insert, fumé glass shelves with piombo painted frame. Pull-out dresser valet mat lacquered piombo, boxes, watch and jewels trays with structure covered in leather and inner silk pads.



In alto: maniglia Gap verniciato piombo con inserto in tecnopelle 01 visone. Nella pagina a destra: portapantaloni con vassoio portaoggetti nobilitato rovere cenere, vaschette con struttura rivestita in pelle visone e interni in seta.
Above: piombo painted Gap handle with 01 visone techno-leather insert. To the right: trousers hanger with tray in cenere oak melamine, boxes covered in visone leather and inner silk pads.



In questa pagina: cassetto in nobilitato rovere cenere con fondo rivestito in tecnopelle 01 visone.
Ripiano in tecnopelle 01 visone con telaio verniciato piombo. Nella foto a destra: contenitore porta borse
nobilitato rovere cenere con ripiani interni laccato opaco piombo.



To the left: drawer in cenere oak melamine with bottom covered in 01 visone techno-leather. Shelf in 01 visone
techno-leather with piombo painted frame. This pagew: handbag storage in cenere oak melamine with piombo
mat lacquered inner shelves.





Nella foto in alto: dettaglio della maniglia Volo verniciato piombo. Nella pagina a destra: armadio Senzafine New Entry con ante laccato lucido moka. Ripiani porta scarpe inclinati nobilitato rovere cenere con bordi in alluminio verniciato piombo e illuminazione integrata led. Scatole rivestite in tessuto.

Above: detail of Volo handle in painted piombo. Right: Senzafine New Entry wardrobe with moka glossy lacquered doors. Shoestand inclined shelves in cenere oak melamine with piombo painted aluminium frame and built-in led lamps. Boxes covered in fabric.





Nella pagina precedente e in questa: letto Jacqueline in tessuto sfoderabile Lima 43 ecrù, cucitura 1282 acciaio. Coordinato letto Provence 01 bianco, 06 roccia. Tavolino Flute laccato opaco nero, piano in emperador dark. Comodino Pandora rovere spessart. Poltrona Mad Chair rovere spessart e rivestimento in velluto sfoderabile Persia 1401 oliva. Pouf Play rivestito in velluto sfoderabile Persia 1403 ocra. Nella foto in alto: un dettaglio della testata con il disegno creato dalle cuciture in contrasto.

Previous and this page: Jacqueline bed in 43 ecrù Lima removable fabric, stitching 1282 acciaio. Bed-set Provence 01 bianco, 06 roccia. Nero mat lacquered Flute coffee table, emperador dark marble top. Pandora night table in spessart oak. Mad Chair armchair in spessart oak and 1401 oliva Persia removable velvet covering. Play pouf covered in 1403 ocra Persia removable fabric. Above: a detail of the headboard with the stitching in contrasting colour.

Senzafine cabina armadio h 2590 p 584
 finitura: nobilitato rovere cenere
 attrezzatura: nobilitato rovere cenere,
 tecnopelle 01 visone, verniciato piombo

Senzafine walk-in closet h 102" d 23"
 finishing: cenere oak melamine
 equipment: cenere oak melamine
 01 visone Techno-leather, piombo painted

New Entry armadi h 2590 p 609
 ante: New Entry apertura battente, maniglie
 Volo verniciato piombo
 finitura ante: laccato lucido moka
 interni: nobilitato rovere cenere,
 tecnopelle 01 visone, verniciato piombo

New Entry wardrobes h 102" d 24"
 doors: New entry leaf opening, Volo handles
 piombo painted
 doors finishing: moka glossy lacquered
 inner equipment: cenere oak melamine,
 01 visone techno-leather, piombo painted

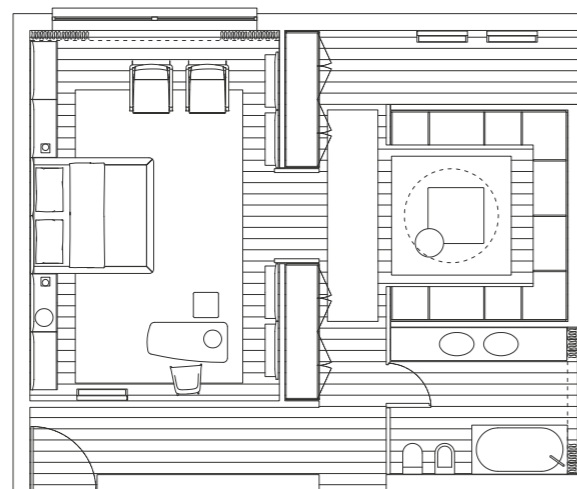

Senzafine cabina armadio/walk-in closet design Rodolfo Dordoni



New Entry armadi/wardrobes design CR&S Poliform



INTERIOR 03

TECHNICAL DATA

Dream letto
giroletto e testata centrale pelle sfoderabile
Special 40 ardesia, boiserie velluto sfoderabile
Persia 1404 carbone

Dream bed
base and central wall panelling in removable
40 ardesia Special leather, wall panelling in removable
1404 carbone Persia velvet

Dream comodini
finitura laccato lucido moka

Dream night tables
moka glossy lacquered

Dream boiserie
velluto Persia 1404 carbone, mensole laccato
lucido visone

Dream wall panelling
1404 carbone Persia velvet and shelves visone glossy
lacquered

Concorde scrittoio
finitura rovere spessart

Concorde writing desk
spessart oak

Manta sedia
pelle Vintage 96 nero

Manta chair
96 nero Vintage leather

Gaston poltrona
pelle Super 7 nero, struttura metallo verniciato
nero lucido

Gaston armchair
7 nero Super leather, black glossy metal painted
structure

Onda pouf
velluto sfoderabile Persia 1401 oliva

Onda pouf
removable 1401 oliva Persia fabric

Gant pouf
pelle Nabuk 1 latte

Gant pouf
1 latte Nabuk leather

Tribeca tavolino
struttura metallo verniciato brown nickel opaco,
piano in marmo emperador dark

Tribeca coffee table
mat brown nickel painted metal structure with
emperador dark marble top

Jacqueline letto
tessuto sfoderabile Lima 43 ecrù cucitura 1282
acciaio

Jacqueline bed
43 ecrù Lima removable fabric and 1282 acciaio
stitching

Flute tavolino
struttura laccato opaco nero, piano marmo
emperador dark

Flute coffee table
nero mat lacquered structure, emperador dark marble
top

Pandora comodino
finitura rovere spessart

Pandora night table
spessart oak

Play pouf
velluto sfoderabile Persia 1403 ocra

Play pouf
1403 ocra Persia removable velvet

Mad Chair poltrona
velluto sfoderabile Persia 1401 oliva, gambe
rovere spessart

Mad Chair armchair
1401 oliva Persia removable velvet, spessart oak legs

Dream design Marcel Wanders

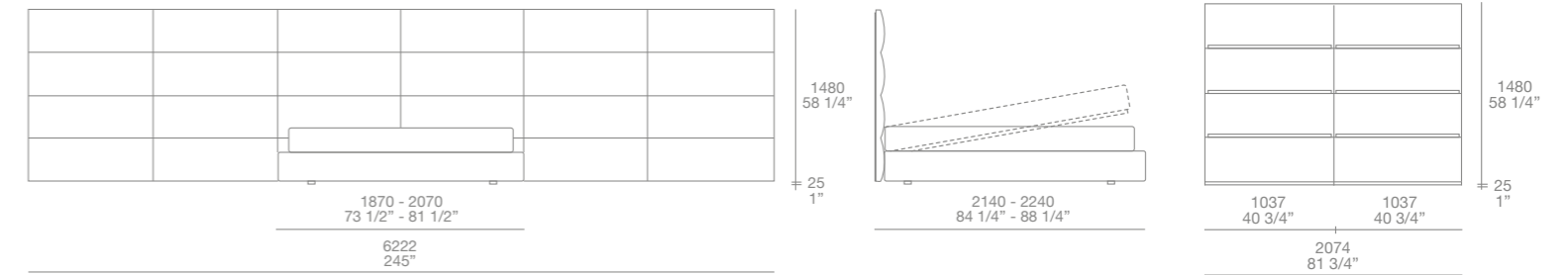

Dream design Marcel Wanders



Tribeca design Jean-Marie Massaud

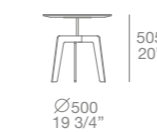

Gant design CR&S Poliform

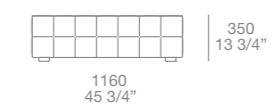

Onda design CR&S Poliform



Gaston design Vincent Van Duysen

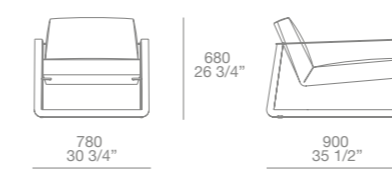

Concorde design Emmanuel Gallina

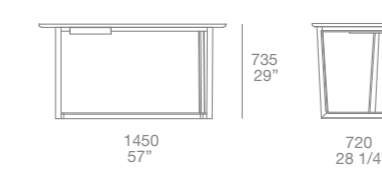

Manta design Rodrigo Torres

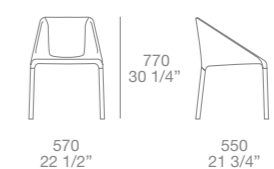

Jacqueline design Jean-Marie Massaud

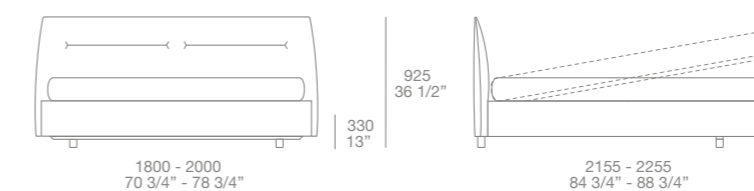

Mad Chair design Marcel Wanders

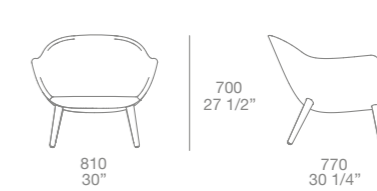

Pandora design Jean-Marie Massaud

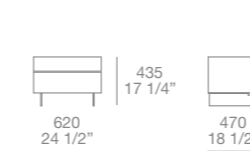

Play design CR&S Poliform



Flute design Roberto Barbieri

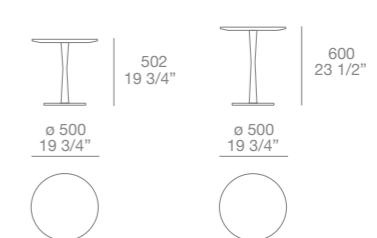

A NOBLE AMBIENCE
 ENRICHED BY
 UNEDITED GEOMETRIES
 REINTERPRET THE
 CONCEPT OF CLASSIC

In questo progetto: letto Bruce, testata alta in tessuto sfoderabile Limoges 2 visone e giroletto in velluto sfoderabile Persia 23 arena. Armadi Senzafine Ocean apertura battente, ante in vetro satinato nero, profili alluminio verniciato opaco carbone, maniglie Sydney. Armadi Senzafine Fitted apertura battente, ante in vetro fumè con composizione Quid, pannelli boiserie in olmo nero e bacheca laccato opaco piombo.

This project: Bruce bed, high headboard with removable fabric Limoges 2 visone and bed frame with removable velvet Persia 23 arena. Senzafine Ocean wardrobes with leaf opening, black frosted glass doors, carbone mat painted aluminium profiles, Sydney handles. Senzafine Fitted wardrobes with leaf opening, fumè glass doors with Quid composition, black elm wall panelling and piombo mat lacquered units.







Nelle pagine precedenti: letto Bruce con testata sfoderabile Limoges 2 visone e giroletto in velluto sfoderabile Persia 23 arena. Coordinato letto Provence 01 bianco profilo bianco. Armadi Senzafine Ocean apertura battente, ante in vetro satinato nero con profili in alluminio verniciato opaco carbone e maniglie Sydney. Comodino Giò olmo nero. Poltrona Mad Queen scocca esterna e gambe in pelle Nabuk 1 latte, interno e cuscino seduta Norway 8 avorio. Pouf Elise in pelle sfoderabile Nabuk 1 latte. In questa pagina: letto Bruce con testata sfoderabile Limoges 2 visone e giroletto velluto sfoderabile Persia 23 arena. Comodino Giò in olmo nero con piano cuoio 28 avorio e piano superiore in vetro trasparente extrachiario.

Previous pages: Bruce bed, headboard with removable fabric Limoges 2 visone and bed frame with removable velvet Persia 23 arena. Bed linen Provence 01 bianco piping. Senzafine Ocean wardrobes leaf door, black frosted glass door, mat carbone painted aluminium profiles and Sydney handles. Black elm Giò night-table Mad Queen armchair, Nabuk 1 latte leather external body and legs, Norway 8 avorio seat cushion and interior.

Elise pouf in removable leather Nabuk 1 latte. This page: Bruce bed, headboard with removable fabric Limoges 2 visone and bed frame with removable velvet Persia 23 arena. Black elm Giò night-table with leather 28 avorio shelf and extra-light transparent glass top.



In questa pagina: letto Bruce con testata sfoderabile Limoges 2 visone e giroletto in velluto sfoderabile Persia 23 arena. Coordinato letto Provence 01 bianco profilo bianco. Comodino Giò in olmo nero con piano cuoio 28 avorio e piano superiore in vetro trasparente extrachiario. Pouf Onda rivestito in velluto sfoderabile Persia 2006 prugna.

This page: Bruce bed, headboard with removable fabric Limoges 2 visone and bed frame with removable velvet Persia 23 arena. Bed linen Provence 01 bianco piping. Black elm Giò night-table with leather 28 avorio shelf and extralight transparent glass top. Onda pouf covered in Persia 2006 prugna removable velvet.



In questa pagina: letto Bruce con testata sfoderabile Limoges 2 visone e giroletto in velluto sfoderabile Persia 23 arena. Coordinato letto Provence 01 bianco profilo bianco. Comodino Giò in olmo nero. Cassettiera Giò in olmo nero con piano cuoio 28 avorio. Poltrona Mad Queen con scocca esterna e gambe in pelle Nabuk 1 latte, interno e cuscino seduta Norway 8 avorio. Pouf Elise in pelle sfoderabile Nabuk 1 latte. Pouf Onda rivestito in velluto sfoderabile Persia 2006 prugna.

This page: Bruce bed, headboard with removable fabric Limoges 2 visone and bed frame with removable velvet Persia 23 arena. Bed linen Provence 01 bianco piping. Black elm Giò night-table. Black elm Giò chest of drawers with avorio leather top. Mad Queen armchair, Nabuk 1 latte leather external body and legs, Norway 8 avorio seat cushion and interior. Elise pouf in removable leather Nabuk 1 latte. Onda pouf covered in Persia 2006 prugna removable velvet.



In questa pagina: cassettera Giò finitura olmo nero con piano laccato lucido canapa, fianchi interni verniciato brown nickel lucido.
This page: black elm finishing Giò chest of drawers with canapa glossy lacquered top, inner sides painted glossy brown nickel.





In questa pagina: letto Bruce con testata sfoderabile Limoges 2 visone e giroletto in velluto sfoderabile Persia 23 arena. Armadi Senzafine Ocean apertura battente, ante in vetro satinato nero. Armadi Senzafine Fitted apertura battente, ante in vetro fumè e telaio opaco carbone con composizione Quid, pannelli boiserie in olmo nero e bacheca laccato opaco piombo. Pouf Elise in pelle sfoderabile Nabuk 1 latte.

This page: Bruce bed, high headboard with removable fabric Limoges 2 visone and bed frame with removable velvet Persia 23 arena. Senzafine Ocean wardrobes with leaf opening, black frosted glass doors, carbone mat painted aluminium profiles, Sydney handles. Senzafine Fitted wardrobes with leaf opening, fumé glass doors with Quid composition, black elm wall panelling and piombo mat lacquered units. Elise pouf in removable leather Nabuk 1 latte.





Nella pagina precedente: armadi Senzafine Ocean apertura battente, ante in vetro satinato nero. Armadi Senzafine Fitted apertura battente, ante in vetro fumè e telaio laccato opaco carbone con composizione Quid con pannelli boiserie e schienali in olmo nero, bacheca laccato opaco carbone, cassetti cuoio 26 invecchiato e ripiani in vetro trasparente. Illuminazione led integrata. In questa pagina: armadio Senzafine Ocean apertura battente, ante in vetro satinato nero e profili in alluminio verniciato opaco carbone, maniglie Sydney a incasso e fianchi laccato opaco carbone. Letto Bruce con testata sfoderabile Limoges 2 visone e giroletto in velluto sfoderabile Persia 23 arena. A destra: armadio Senzafine Ocean, interno in nobilitato rovere spessart, tecnopelle 05 latte, verniciato piombo.

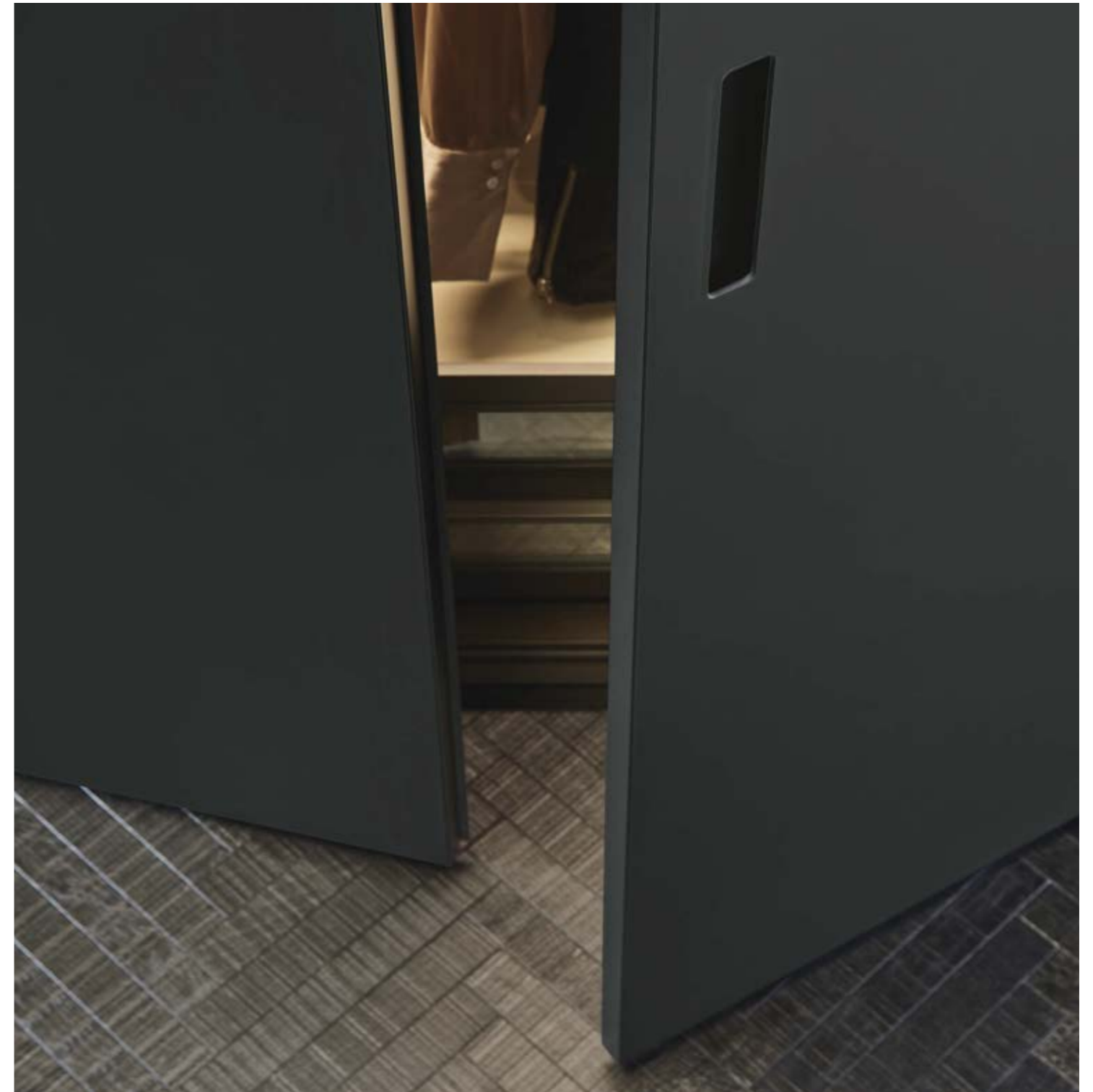

Previous page: Senzafine Ocean wardrobes with leaf opening, black frosted glass doors. Senzafine Fitted wardrobes with leaf opening, fumé glass doors and carbone mat lacquered frame; Quid composition with black elm wall panelling and backs, mat lacquered carbone units, drawers in hide 26 invecchiato. Integrated LED lighting. To the left: Senzafine Ocean wardrobes with leaf opening, black frosted glass doors, carbone mat lacquered sides, built-in Sydney handles and carbone mat lacquered sides. Bruce bed with headboard with removable fabric Limoges 2 visone and bed frame with removable velvet Persia 23 arena. Above: Senzafine Ocean wardrobe, interiors in spessart oak melamine, techno-leather 05 latte and piombo painted metal.



In questa pagina: armadi Senzafine Ocean apertura battente, ante in vetro satinato nero e profili in alluminio verniciato opaco carbone. Armadi Senzafine Fitted apertura battente, ante in vetro fumè con profili, fianchi e maniglie Fitted laccato opaco carbone. Interni in nobilitato rovere spessart e verniciato piombo. Panca Home Hotel Collection in olmo nero con cuscino in pelle Nabuk 1 latte.

This page: Senzafine Ocean wardrobes with leaf opening, black frosted glass doors, carbone mat painted aluminium profiles. Senzafine Fitted wardrobes with leaf opening, fumé glass doors with profiles, sides and Fitted handles mat lacquered carbone. Spessart oak melamine and piombo painted interior. Black elm Home Hotel Collection bench with Nabuk 1 latte leather cushion.

Ocean armadi h 2590 p 616
 ante: Ocean apertura battente
 finitura: vetro satinato nero, profili alluminio verniciato opaco carbone, maniglia Sydney a incasso, fianchi laccato opaco carbone
 interni: nobilitato rovere spessart, tecnopelle 05 latte, verniciato piombo

Fitted armadi h 2590 p 609
 ante: Fitted apertura battente
 finitura: vetro fumè con profili e maniglie Fitted laccato opaco carbone, fianchi laccato opaco carbone
 interni: nobilitato rovere spessart, verniciato piombo

Quid
 pannelli boiserie l 1200, finitura olmo nero
 bacheca h 300 p 200 laccato opaco carbone, schienali olmo nero, cassetti cuoio 26 invecchiato, ripiani vetro trasparente, illuminazione led integrata

Ocean wardrobes h 102" d 24 1/4"
 door: Ocean leaf opening
 finishing: black frosted glass, carbone mat painted profiles, built-in Sydney handle, carbone mat lacquered sides
 interior: spessart oak melamine, techno-leather 05 latte, piombo painted

Fitted wardrobes h 102" d 24"
 door: Fitted leaf opening
 finishing: fumè glass with carbone mat lacquered frame and Fitted handles, carbone mat lacquered sides
 interior: spessart oak melamine, piombo painted

Quid
 wall panelling w 47 1/4", black elm finishing units h 11 3/4" d 7 3/4" mat lacquered carbone, black elm backs, drawers in hide 26 invecchiato, transparent glass shelves, integrated led lighting

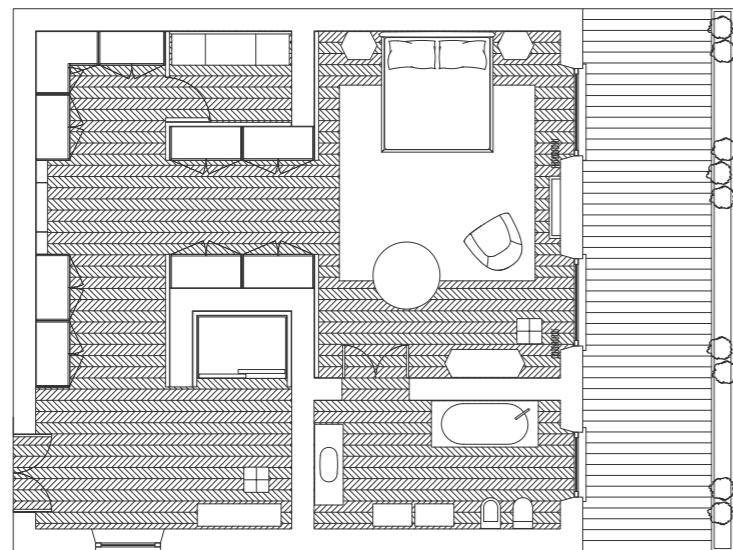

Ocean armadi/wardrobes design CR&S Poliform

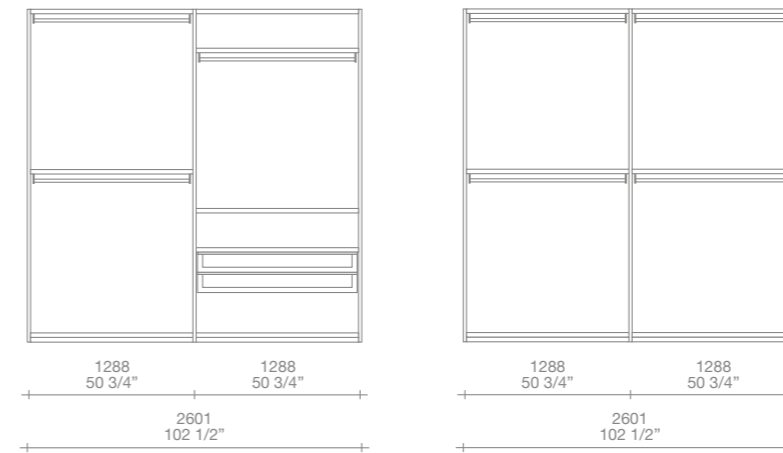

Fitted armadi/wardrobes design Rodolfo Dordoni - Quid design CR&S Poliform



Bruce letto
testata tessuto sfoderabile Limoges 2 visone,
giroletto velluto sfoderabile Persia 23 arena

Giò comodino
olmo nero, piano cuoio 28 avorio,
piano superiore vetro trasparente extrachiario

Elise pouf
pelle sfoderabile Nabuk 1 latte

Giò cassettiere
olmo nero, piano laccato lucido canapa e cuoio
28 avorio, fianchi interni verniciato brown nickel
lucido

Mad Queen poltrona
scocca esterna e gambe pelle Nabuk 1 latte,
interno scocca e cuscino seduta Norway 8 avorio

Onda pouf
velluto sfoderabile Persia 2006 prugna

Home Hotel Collection
panca in olmo nero, cuscino pelle Nabuk 1 latte

Bruce bed
headboard in removable fabric Limoges 2 visone,
removable velvet frame Persia 23 arena

Giò night table
black elm, hide 28 avorio shelf,
extralight transparent glass top

Elise pouf
removable leather Nabuk 1 latte

Giò chest of drawers
black elm, canapa glossy lacquered and hide
28 avorio top, brown nickel glossy painted inner
sides

Mad Queen armchair
Nabuk leather 1 latte external body and legs, inner
covering and seat cushion in Norway 8 avorio

Onda pouf
removable velvet Persia 2006 prugna

Home Hotel Collection
black elm bench, Nabuk 1 latte leather cushion

Bruce design Jean-Marie Massaud

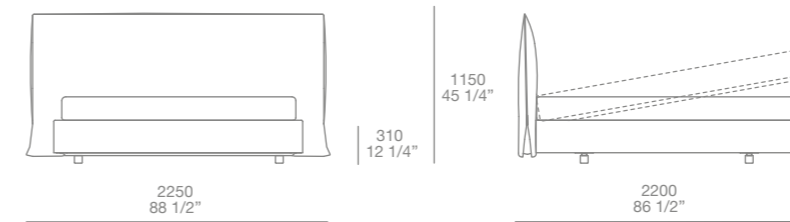

Giò design Rodolfo Dordoni

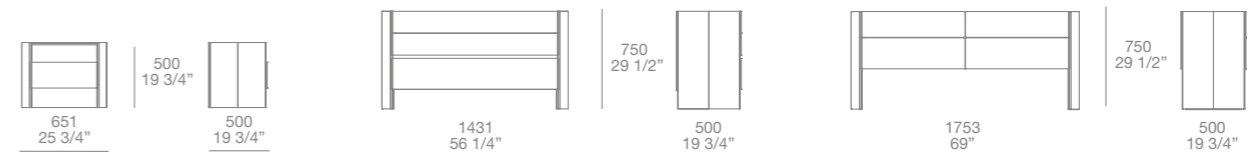

Mad Queen design Marcel Wanders

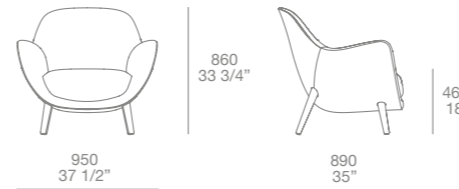

Home Hotel Collection design Jean-Marie Massaud

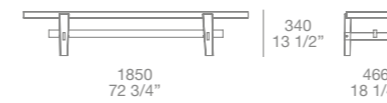

Onda design CR&S Poliform

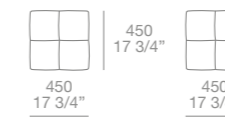

Elise design CR&S Poliform

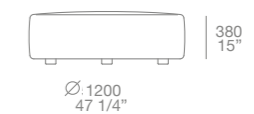

NATURAL MATERIALS TURN THE PROJECT INTO A LIVING PHILOSOPHY

In questo progetto: letto Onda rivestito in pelle Invecchiata 880 nero con lavorazione capitonnè. Armadi Senzafine Bangkok complanare, ante in cuoio 3 grigio scuro. Cabina armadio Ubik con pannelli a parete laccato opaco visone, ripiani e cassettiere sospese nobilitato rovere cenere.

This project: Onda bed in 880 black Invecchiata leather with quilted padding. Senzafine Bangkok wardrobes with 3 grigio scuro hide coplanar doors. Ubik walk-in closet with visone mat lacquered wall panels, shelves and hanging chest of drawers in cenere oak melamine.





Nelle pagine precedenti: letto Onda rivestito in pelle Invecchiata 880 nero con lavorazione capitonnè, comodino Onda rovere spessart. Coordinato letto Provence 01 bianco profilo nero. In questa pagina: armadi Senzafine Bangkok complanare, ante in cuoio 3 grigio scuro. Poltrona Ventura lounge rovere spessart e tessuto sfoderabile Norway 8 avorio, cuciture a cordoncino nero. Pouf Play rivestimento in velluto sfoderabile Persia 58 danubio.

Previous pages: Onda bed in 880 black Invecchiata leather with quilted padding, Onda night table in spessart oak. Bed-set 01 bianco Provence with black piping stitching style. This page: Senzafine Bangkok wardrobes with 3 grigio scuro hide coplanar doors. Ventura lounge armchair in spessart oak and 8 avorio Norway removable fabric, black drawstring stitch. Play pouf with 58 danubio Persia removable velvet covering.







Nelle pagine precedenti e in questa: armadi Senzafine Bangkok complanare, ante in cuoio 3 grigio scuro. Interni in nobilitato rovere cenere, portacamicie tecnopelle 01 visone. Poltrona Ventura lounge rovere spessart e tessuto sfoderabile Norway 8 avorio, cuciture a cordoncino nero. Tavolino Tribeca verniciato brown nickel opaco e marmo calacatta oro. Pouf Elise in tessuto sfoderabile Rabat 412 cemento, cucitura a cordoncino nero. Poltroncina Guest e pouf Play rivestimento in velluto sfoderabile Persia 58 danubio.

Previous and this page: Senzafine Bangkok wardrobes with 3 grigio scuro hide coplanar doors. Inner equipment in cenere oak, shirt storage in 01 visone techno-leather. Ventura lounge armchair in spessart oak and 8 avorio Norway removable fabric, black drawstring stitch. Tribeca coffee table mat brown nickel painted and calacatta oro marble. Elise pouf in 412 cemento Rabat removable fabric, black drawstring stitch. Guest armchair and Play pouf with 58 danubio Persia removable velvet covering.



In questa pagina, nella foto sopra: dettaglio dell'anta complanare dell'armadio Bangkok, rivestita in cuoio con cuciture a vista. Traverso centrale laccato opaco piombo con maniglia integrata. Nella foto a destra: interni nobilitato rovere cenere, vassoi estraibili in nobilitato rovere cenere con rivestimento in tecnopelle visone. Pagina successiva: Senzafine Bangkok complanare, ante in cuoio 3 grigio scuro. Tavolino Tribeca verniciato brown nickel opaco e marmo calacatta oro. Pouf Elise in tessuto sfoderabile Rabat 412 cemento, cucitura a cordoncino nero. Poltroncina Guest e pouf Play rivestimento in velluto sfoderabile Persia 58 danubio.



To the left: detail of Bangkok wardrobe coplanar door covered in hide with stitching. Central crossbar piombo mat lacquered with built-in handle. Above: inner equipment in cenere oak melamine, pull-out trays in cenere oak melamine with covering in visone techno-leather. Following page: Senzafine Bangkok wardrobes with 3 grigio scuro hide coplanar doors. Tribeca coffee table mat brown nickel painted and calacatta oro marble. Elise pouf in 412 cemento Rabat removable fabric, black drawstring stitch. Guest armchair and Play pouf with 58 danubio Persia removable velvet covering.







Nelle pagine precedenti: cabina armadio Ubik con pannelli a parete laccato opaco visone, ripiani e cassettiere sospese nobilitato rovere cenere. Basamento nobilitato rovere cenere con zoccolo in alluminio verniciato piombo. Sopra: cassetti nobilitato rovere cenere con frontale in cristallo trasparente, maniglia Track verniciato piombo.

Previous pages: Ubik walk-in closet with visone mat lacquered wall panels, shelves and hanging chest of drawers in cenere oak melamine. Base in cenere oak melamine with plinth in piombo painted aluminium. Above: drawers in cenere oak melamine with front in transparent glass. Piombo painted Track handle.



Sopra: dettaglio del cassetto con maniglia Track verniciato piombo. A destra: portapantaloni nobilitato rovere cenere con vassoio portaoggetti superiore. Il vassoio dispone di un'attrezzatura liberamente componibile che comprende vaschette, portaorologi, porta orecchini, porta gemelli e anelli con struttura rivestita in pelle visone e interni in seta.



To the left: detail of the drawer with piombo painted Track handle. Above: trousers hanger in cenere oak melamine with upper tray. The tray could be equipped with boxes, watch tray, earrings tray, cufflinks and rings tray with structure covered in visone leather and inner silk pads.



In questa pagina: cabina armadio Ubik pannelli laccato opaco visone, ripiani e cassettiere sospese nobilitato rovere cenere. Pouf Play rivestimento in velluto sfoderabile Persia 58 danubio.
This page: Ubik walk-in closet with visone mat lacquered panels, shelves and hanging chest of drawers in cenere oak melamine. Play pouf with 58 danubio Persia removable velvet covering.

Ubik cabina armadio h 2590
 finitura pannelli: laccato opaco visone
 attrezzatura: nobilitato rovere cenere,
 tecnopelle 01 visone, verniciato piombo

Bangkok armadi h 2590 p 609
 ante: apertura complanare
 finitura: cuoio 3 grigio scuro
 interni: nobilitato rovere cenere,
 tecnopelle 01 visone, verniciato piombo

Ubik walk-in closet h 102"
 panels finishing: visone mat lacquered
 equipment: cenere oak melamine,
 01 visone techno-leather, piombo painted

Bangkok wardrobes h 102" d 24"
 doors: coplanar doors opening
 finishing: 3 grigio scuro hide
 inner equipment: cenere oak melamine,
 01 visone techno-leather, piombo painted

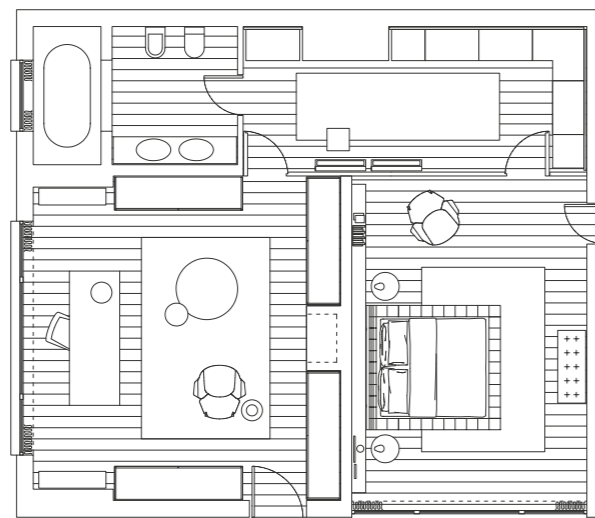

Ubik cabina armadio/walk-in closet design CR&S Poliform

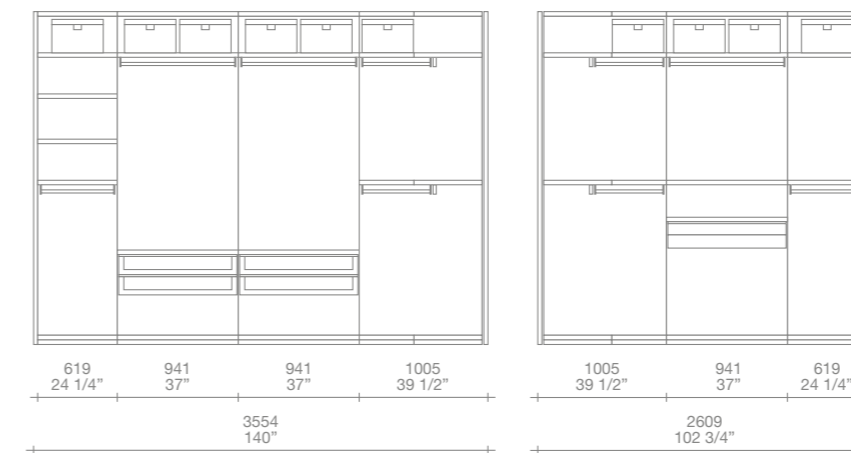

Bangkok armadi/wardrobes design Operadesign



Onda letto
pelle Invecchiata 880 nero

Onda comodini
struttura e piano rovere spessart

Ventura Lounge poltrona
tessuto sfoderabile Norway 8 avorio,
struttura rovere spessart

Guest sedia
velluto sfoderabile Persia 58 danubio

Play pouf
velluto sfoderabile Persia 58 danubio

Elise pouf
tessuto sfoderabile Rabat 412 cemento

Tribeca tavolino
struttura verniciato brown nickel opaco,
piano marmo calacatta oro

Onda bed
880 black Invecchiata leather

Onda night tables
top and structure in spessart oak

Ventura Lounge armchair
8 avorio Norway removable fabric, spessart
oak structure

Guest chair
58 danubio Persia removable velvet

Play pouf
58 danubio Persia removable fabric

Elise pouf
412 cemento Rabat removable fabric

Tribeca coffee table
mat brown nickel painted structure
and calacatta oro marble top

Onda design Paolo Piva



Onda design CR&S Poliform

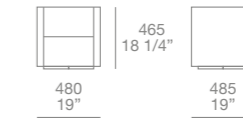

Ventura Lounge design Jean-Marie Massaud

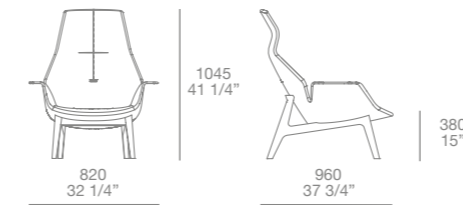

Guest design Rodolfo Dordoni

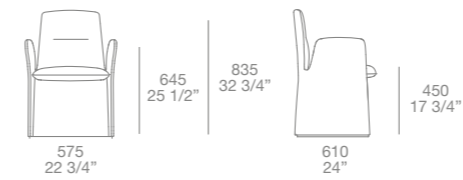

Tribeca design Jean-Marie Massaud



Elise design CR&S Poliform

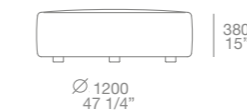

Play design CR&S Poliform

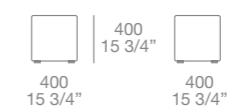

MEMORY MEETS PRESENT THROUGH EXCLUSIVE SOLUTIONS

In questo progetto: letto Bolton, base e testata con rivestimento in tessuto sfoderabile Cordoba 10 bianco. Cassettiera Senzafine ad isola finitura rovere cenere. Armadi Senzafine Fitted battente, ante laccato opaco bianco e vetro trasparente riflettente.

This project: Bolton bed with base and headboard covered in 10 bianco Cordoba removable fabric. Senzafine island chest of drawers in cenere oak. Senzafine Fitted wardrobes, bianco mat lacquered and reflecting transparent glass leaf opening.







Nelle pagine precedenti e in questa: letto Bolton, base e testata con rivestimento in tessuto sfoderabile Cordoba 10 bianco. Coordinato letto Provence 06 roccia profilo polvere, 01 bianco profilo roccia. Comodino Abbinabili rovere spessart. Tavolino Bigger rovere spessart e piano in marmo emperador dark lucido. Poltrone Mad Chair rovere spessart e rivestimento in velluto sfoderabile Persia 54 prussia. Pouf Onda rivestito in tessuto sfoderabile Merida 04 lava.

Previous and this page: Bolton bed with base and headboard covered in 10 bianco Cordoba removable fabric. Bed-set in 06 roccia Provence and polvere piping stitching syle, 01 bianco and roccia piping stitching syle. Abbinabili night table in spessart oak. Bigger coffee table in spessart oak and glossy emperador dark marble top. Mad Chair armchairs in spessart oak and 54 prussia Persia removable velvet covering. Onda pouf covered in 04 lava Merida removable fabric.

In questa pagina e nella successiva: cassettera Senzafine ad isola finitura rovere cenere. Armadi Senzafine Fitted battente, ante laccato opaco bianco e vetro trasparente riflettente. Poltrone Mad Chair rovere spessart e rivestimento in velluto sfoderabile Persia 54 prussia.

This and next page: Senzafine island chest of drawers in cenere oak. Senzafine Fitted wardrobes, bianco mat lacquered and reflecting transparent glass leaf opening. Mad Chair armchairs in spessart oak and 54 prussia Persia removable velvet covering.







In questa pagina: cassettera interna nobilitato rovere cenere, vassoi rivestiti in tecnopelle 02 moka, ripiano in tecnopelle con telaio verniciato piombo. Contenitore svuota tasche laccato opaco piombo con piano e vani estraibili rivestiti in tecnopelle 02 moka.



This page: inner chest of drawers in cenere oak melamine, trays covered in 02 moka techno-leather, shelf covered in techno-leather with piombo painted metal frame. Mat lacquered piombo dresser valet with bottom and pull out spaces covered in 02 moka techno-leather.





Nella pagina precedente e in questa: armadio Senzafine Fitted apertura battente in una composizione a doppia profondità, moduli laterali p 464 ante laccato opaco bianco, modulo centrale p 609 ante in vetro trasparente riflettente con telaio verniciato piombo. Ripiani in vetro fumé e in tecnopelle 02 moka con telaio verniciato piombo, cassettiere nobilitato rovere cenere con maniglia Track verniciato piombo.

Previous and this page: Senzafine Fitted wardrobe, leaf opening, in a double depth composition, lateral parts d. 18 1/4" bianco mat lacquered doors, central part d. 24" with reflecting transparent glass doors with piombo painted frame. Fumé glass and 02 moka techno-leather shelves with piombo painted frame, cenere oak melamine chest of drawers with piombo painted Track handle.



In questa pagina: cassetiera Senzafine ad isola rovere cenere, top tecnopelle 02 moka con bordo verniciato piombo. Nella foto in alto: cassetto frontale in cristallo trasparente, maniglia Track verniciato piombo, fondo rivestito in tecnopelle, griglia divisoria nobilitato txt piombo.

This page: Senzafine island chest of drawers in cenere oak, 02 moka techno-leather top with piombo painted edge. Above: front drawer in transparent glass, piombo painted Track handle, bottom covered in techno-leather, partition element in txt piombo melamine.

Fitted armadi: ante e interni
 ante: Fitted apertura battente, maniglie Fitted
 interni: nobilitato rovere cenere, tecnopelle 02 moka, verniciato piombo

A - B h 2590 p 464 - 609
 finitura: laccato opaco bianco, vetro trasparente riflettente con telaio verniciato piombo

C h 2590 p 464
 finitura: laccato opaco bianco

D h 2590 p 609
 finitura: laccato opaco bianco

Fitted wardrobes: doors and inner equipment
 doors: Fitted leaf opening, Fitted handles
 inner equipment: cenere oak melamine, 02 moka techno-leather, piombo painted

A - B h 102" d 18 1/4" - 24"
 finishing: bianco mat lacquered, reflecting transparent glass with piombo painted frame

C h 102" d 18 1/4"
 finishing: bianco mat lacquered

D h 102" d 24"
 finishing: bianco mat lacquered

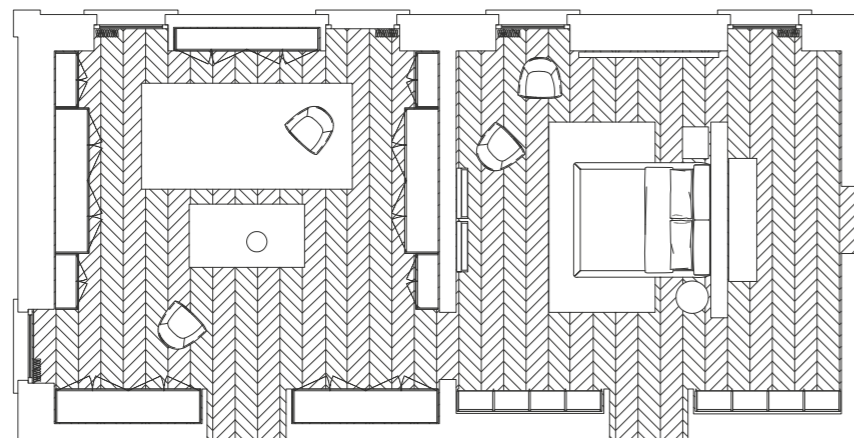

Fitted armadi/wardrobes design Rodolfo Dordoni

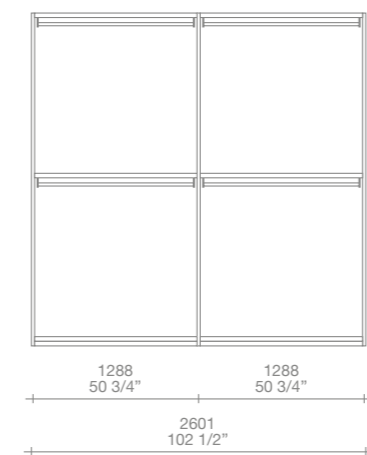
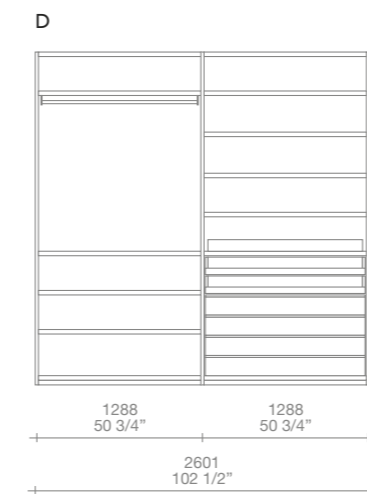
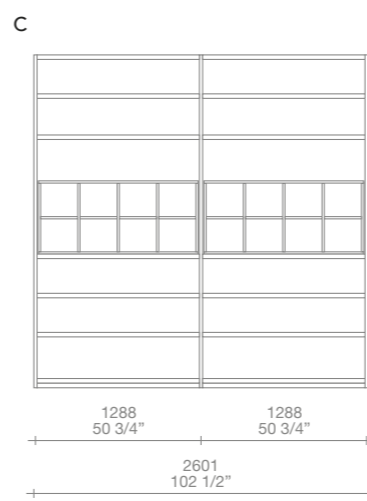
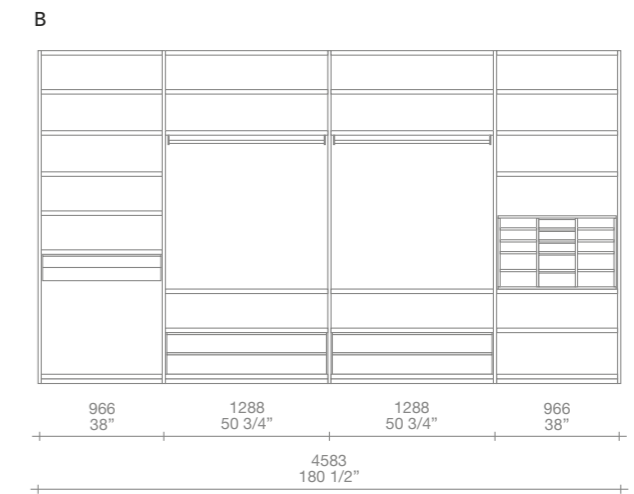
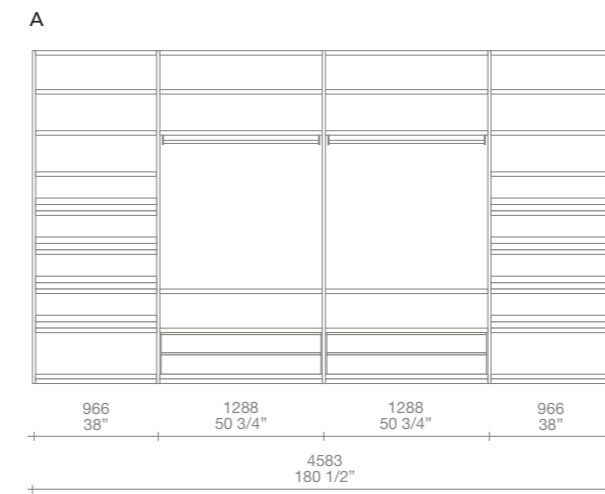

Senzafine cassetiera ad isola
rovere cenere, cassetti legno e cristallo
trasparente con maniglie Track verniciato
piombo, piano superiore tecnopelle 02 moka
con bordi verniciato piombo

Bolton letto
rivestimento tessuto sfoderabile Cordoba
10 bianco

Abbinabili comodino
finitura rovere spessart

Bigger tavolino
struttura rovere spessart, piano marmo
emperador Dark

Onda pouf
tessuto sfoderabile Merida 04 lava

Mad Chair poltrona
velluto sfoderabile Persia 54 prussia, gambe
rovere spessart

Senzafine island chest of drawers
in cenere oak, wood and transparent glass
drawers with piombo painted Track handles,
02 moka techno-leather top with piombo
painted frame

Bolton bed
10 bianco Cordoba removable fabric
covering

Abbinabili night table
finishing in spessart oak

Bigger coffee table
spessart oak structure, emperador Dark
marble top

Onda pouf
04 lava Merida removable fabric

Mad Chair armchair
54 prussia Persia removable velvet covering,
spessart oak legs

Senzafine design CR&S Poliform

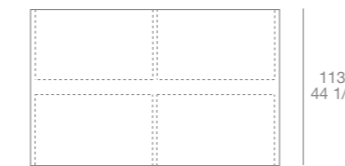
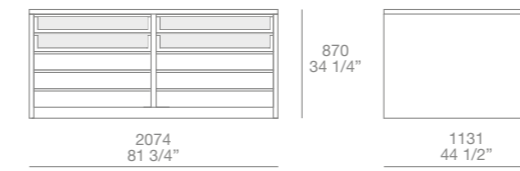

Bolton design Giuseppe Viganò

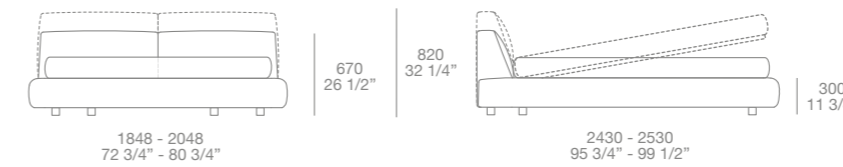

Abbinabili design CR&S Poliform

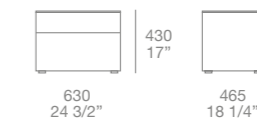

Bigger design Carlo Colombo

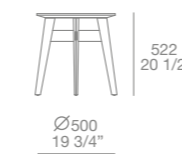

Onda design CR&S Poliform

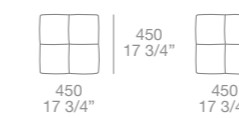

Mad Chair design Marcel Wanders

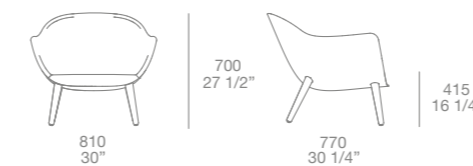

WARDROBE AS AN INNOVATIVE ARCHITECTURAL ELEMENT

In questo progetto: letto Laze, base e testata con rivestimento in pelle sfoderabile Nabuk 02 tortora. Armadi Senzafine Fitted battente, ante laccato opaco visone, maniglie Fitted. Armadi Senzafine Fitted battente, ante vetro trasparente riflettente e telaio alluminio verniciato piombo, maniglie Fitted.

This project: Laze bed, base and headboard with covering in 02 tortora Nabuk removable leather. Senzafine Fitted wardrobes, leaf opening, visone mat lacquered doors, Fitted handles. Senzafine Fitted wardrobes, leaf opening, transparent reflecting glass doors and piombo lacquered aluminium frame with Fitted handle.







Nella pagina precedente e in questa: letto Laze, base e testata con rivestimento in pelle sfoderabile Nabuk 02 tortora. Coordinato letto Provence 01 bianco 08 polvere e 06 roccia profilo nero. Nella foto in alto: comodino Onda in rovere spessart, piano in marmo calacatta oro lucido.

Previous and this page: Laze bed, base and headboard with covering in 02 tortora Nabuk removable leather. Bed-set in 01 bianco, 08 polvere and 06 roccia Provence with black piping stitching style. Above: Onda night table in spessart oak with glossy calacatta oro marble top.





Nella pagina precedente: letto Laze, base e testata con rivestimento in pelle sfoderabile Nabuk 02 tortora. Comodino Onda rovere spessart e piano in marmo calacatta oro lucido. Poltroncina Soori Highline struttura rovere spessart, rivestimento in velluto sfoderabile Persia 2006 prugna, cucitura a cordoncino nero. In questa pagina: cassetiera Onda in rovere spessart, piano in marmo calacatta oro lucido, maniglie rivestite in cuoio. Libreria pensile Slego rovere spessart. In alto: il cassetto superiore attrezzato ha il fondo rivestito in cuoio. Previous page: Laze bed, base and headboard with covering in 02 tortora Nakuk removable leather. Onda night table in spessart oak and glossy calacatta oro marble top. Soori Highline armchair with structure in spessart oak, covering in 2006 prugna Persia removable velvet, black piping stitching style. This page: Onda chest of drawers in spessart oak, top in glossy calacatta oro marble. Handles covered in hide. Slego hanging bookcase in spessart oak. Above: equipped upper drawer with bottom covered in hide.





In questa pagina: interni in nobilitato rovere spessart, ripiano centrale in tecnopelle 03 ocra con telaio verniciato piombo. Contenitore portacamicie con ripiani in tecnopelle ocra, cassetti rivestiti in tessuto e frontale tecnopelle 03 ocra. Cassettiere con frontale cristallo trasparente. Nella foto a destra: ripiano interno in vetro fumé con telaio e tubo portabiti laccato opaco piombo.



This page: inner shelf in fumé glass with frame and hanging rail piombo mat lacquered. To the left: inner equipment in spessart oak melamine, central shelf in 03 ocra techno-leather with piombo lacquered frame. Shirt storage with shelves in ocra techno-leather, drawer covered in fabric and front in 03 ocra techno-leather. Chest of drawers with front in transparent glass.





Nella pagina precedente e in questa: armadi Senzafine Fitted battente, ante vetro trasparente riflettente e telaio alluminio verniciato piombo con maniglia Fitted, fianchi vetro trasparente riflettente e telaio nobilitato rovere spessart. Ripiani interni in tecnopelle 03 ocra con telaio verniciato piombo, lato inferiore nobilitato txt piombo. Pouf Onda rivestito in velluto sfoderabile Persia 1403 ocra.

Previous and this page: Senzafine Fitted wardrobes, leaf opening, transparent reflecting glass doors and piombo lacquered aluminium frame with Fitted handle, sides in transparent reflecting glass and frame in spessart oak melamine. Inner shelves in 03 ocra techno-leather with piombo lacquered frame, bottom in piombo txt melamine. Onda pouf covered in removable 1403 ocra Persia velvet.



In questa pagina: armadi Senzafine Fitted battente, ante vetro trasparente riflettente e telaio alluminio verniciato piombo con maniglia Fitted, fianchi rovere spessart. Ripiani portascarpe nobilitato rovere spessart e bordi in alluminio verniciato piombo.

This page: Senzafine Fitted wardrobes, leaf opening, transparent reflecting glass doors and piombo lacquered aluminium frame with Fitted handle, sides in spessart oak. Shoes storage in spessart oak melamine and frames in piombo painted aluminium.



In questa pagina: armadi Senzafine Fitted apertura battente, ante laccato opaco visone bordo alluminio verniciato piombo. Nella foto in alto: dettaglio della maniglia Fitted verniciato piombo.

This page: Senzafine Fitted wardrobes, leaf opening, visone mat lacquered doors with frame in piombo painted aluminium. Above: detail of piombo painted Fitted handle.

Fitted armadi: ante e interni
 ante: Fitted apertura battente, maniglie Fitted
 interni: nobilitato rovere spessart,
 tecnopelle 03 ocra, verniciato piombo

A - C h 2590 p 609
 finitura: laccato opaco visone

B h 2590 p 609
 finitura: vetro trasparente riflettente con telaio
 alluminio verniciato piombo

D h 2270 p 609
 finitura: vetro trasparente riflettente con telaio
 alluminio verniciato piombo

Fitted wardrobes: doors and inner equipment
 doors: Fitted leaf opening, Fitted handles
 inner equipment: spessart oak melamine,
 03 ocra techno-leather, piombo painted

A - C h 102" d 24"
 finishing: visone mat lacquered

B h 102" d 24"
 finishing: transparent reflecting glass with
 piombo painted aluminium frame

D h 89 3/8" d 24"
 finishing: transparent reflecting glass with
 piombo painted aluminium frame

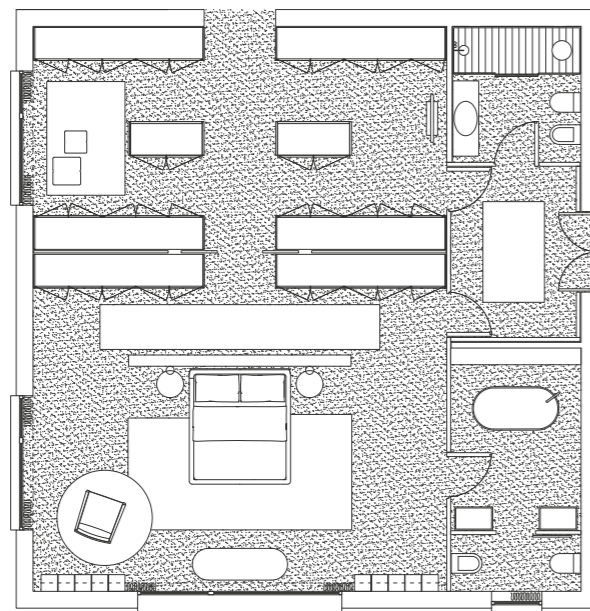

Fitted armadi/wardrobes design Rodolfo Dordoni

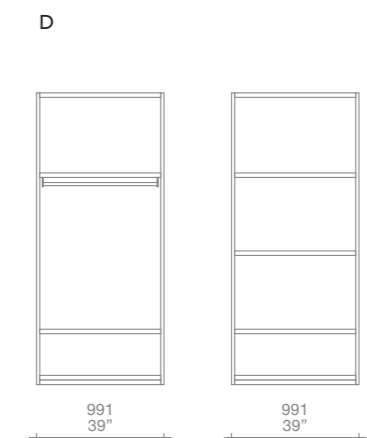
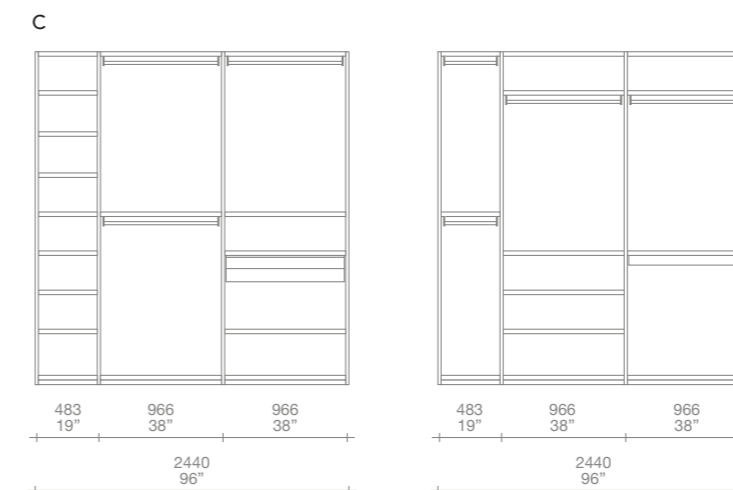
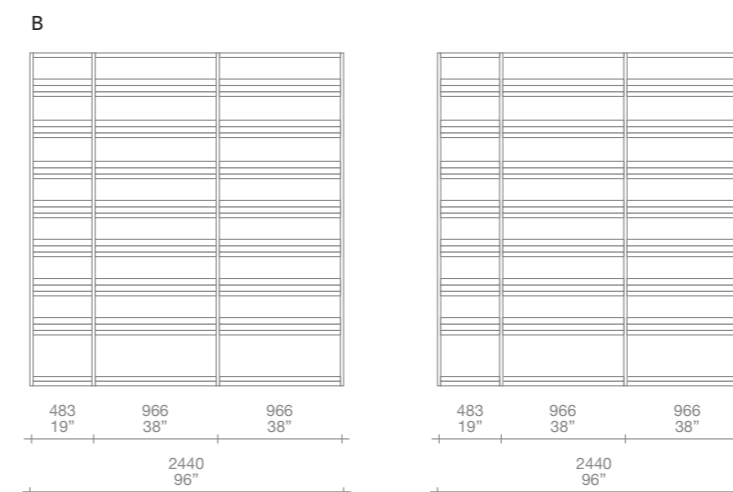

Laze letto
pelle sfoderabile Nabuk 02 tortora

Laze bed
02 tortora Nabuk removable leather

Onda comodino e cassettera
rovere spessart, piano marmo calacatta oro lucido

Onda night table and chest of drawers
spessart oak, top in glossy calacatta oro marble

Onda pouf
in velluto sfoderabile Persia 1403 ocra

Onda pouf
1403 ocra Persia removable velvet

Soori Highline poltroncina
struttura rovere spessart, velluto sfoderabile Persia 2006 prugna

Soori Highline armchair
structure in spessart oak, covering in 2006 prugna Persia removable velvet

Slego libreria
finitura rovere spessart

Slego bookcase
spessart oak

Laze design Rodolfo Dordoni

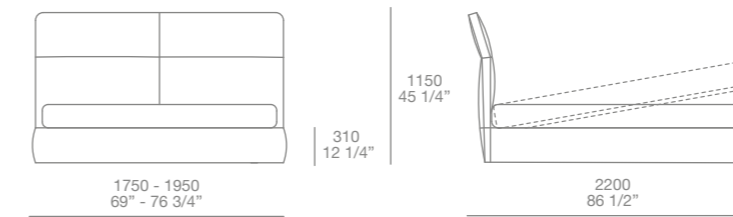

Onda design CR&S Poliform

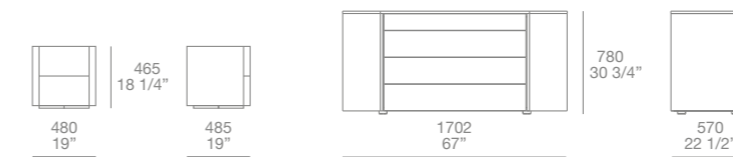

Onda design CR&S Poliform

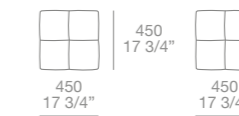

Soori Highline design Soo Chan

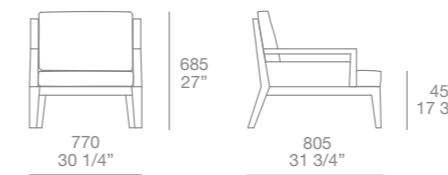

Slego design Roberto Barbieri

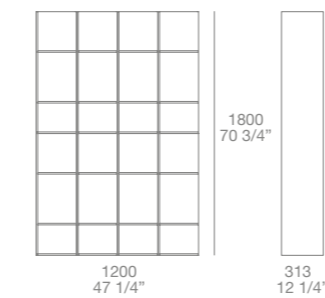

WARDROBES AS WALLS IN AN ORIGINAL ARCHITECTURAL CONCEPT

In questo progetto: letto Arca testata trapuntata, rivestimento sfoderabile pelle Nabuk 01 latte. Armadi Senzafine Fitted apertura battente, ante laccato opaco arena e vetro trasparente riflettente, maniglie Volo verniciato piombo. Cabina armadio Senzafine nobilitato noce c.

This project: Arca bed with quilted headboard, 01 latte Nabuk leather removable covering. Senzafine Fitted wardrobes, leaf opening, arena mat lacquered and reflecting transparent glass doors, piombo painted Volo handles. Senzafine walk-in closet in walnut c. melamine.





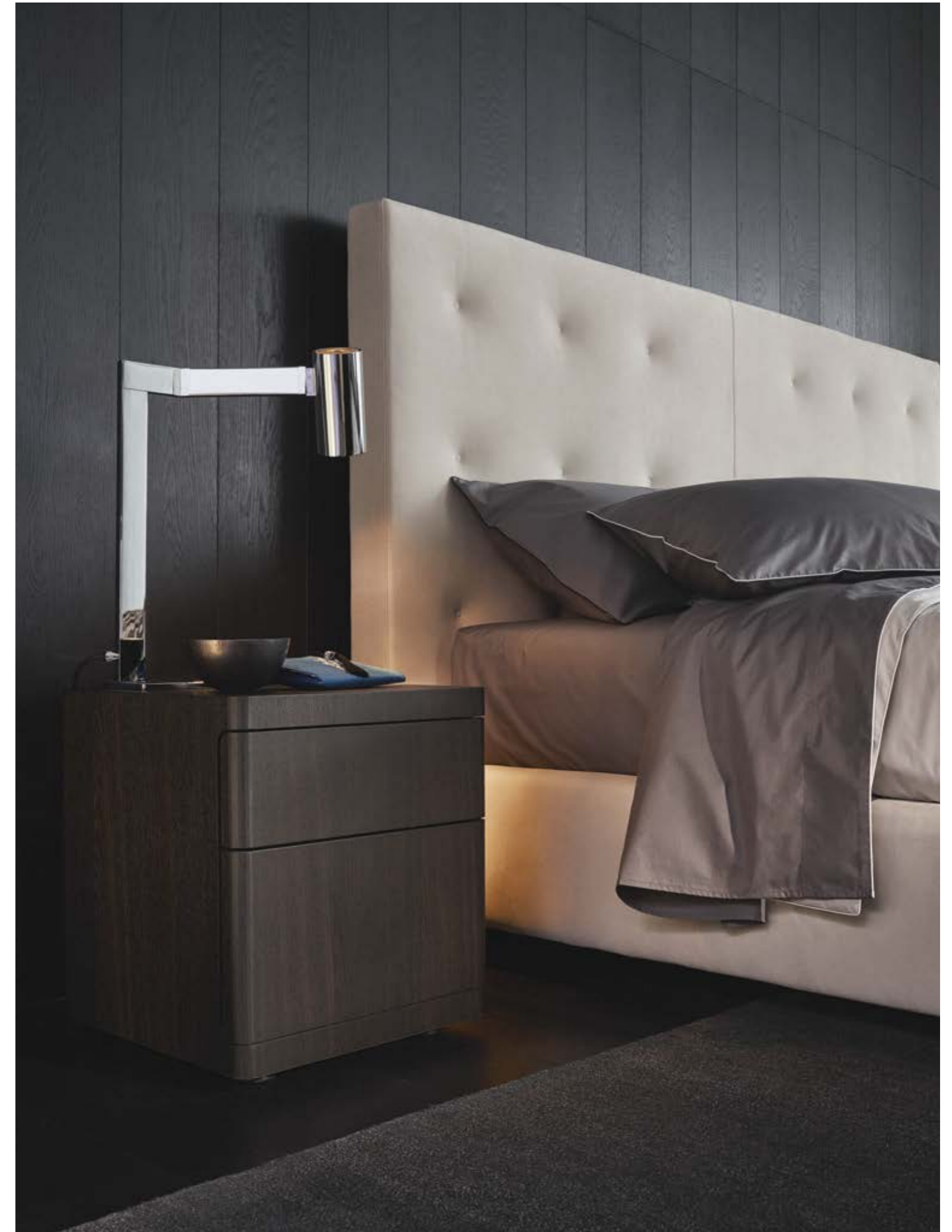

In questa pagina e nella precedente: letto Arca testata trapuntata, rivestimento sfoderabile pelle Nabuk 01 latte. Coordinato letto Provence 06 roccia e 08 polvere profilo bianco. Comodino You rovere spessart. Tavolino Tribeca struttura metallo verniciato brown nickel opaco e piano in marmo calacatta oro.

This and previous page: Arca bed with quilted headboard, 01 latte Nabuk leather removable covering. Bed-set in 06 roccia and 08 polvere Provence with bianco piping stitching style. You night table in spessart oak. Tribeca with mat brown nickel painted metal structure and calacatta oro marble top.

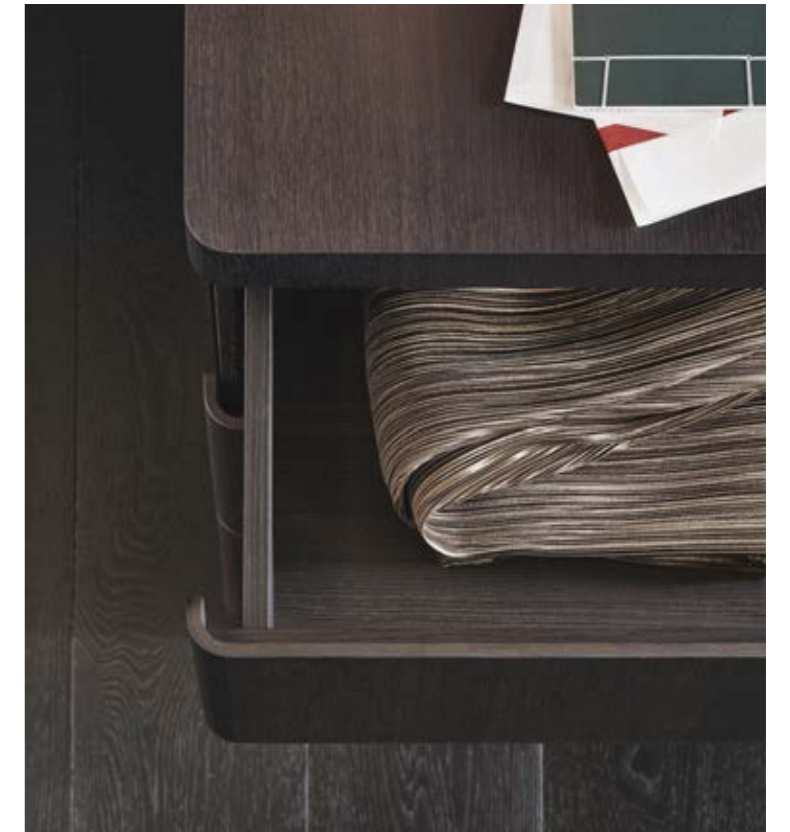

In questa pagina: cassettera You a sei cassetti, finitura rovere spessart. Nella foto in alto: dettaglio del cassetto con i caratteristici spigoli arrotondati. Pouf Dune rivestito in tessuto sfoderabile Rabat 412 cemento.

This page: You chest of drawers with six drawers in spessart oak. Above: drawer detail with distinguished rounded edges. Dune pouf covered in 412 cemento Rabat removable fabric.





Nella pagina precedente: armadi Senzafine Fitted apertura battente, ante laccato opaco arena e vetro trasparente riflettente, maniglie Volo verniciato piombo. Pouf Onda tessuto sfoderabile Merida 04 lava. In questa pagina: cabina armadio Senzafine nobilitato noce c. con fianchi telaio. Nella foto in alto: interni nobilitato noce c. Ripiani vetro fumé con telaio verniciato piombo e illuminazione integrata led.

Previous page : Senzafine Fitted wardrobes, leaf opening, arena mat lacquered and reflecting transparent glass doors, piombo painted Volo handles. Onda pouf in removable 04 lava Merida fabric. This page: Senzafine walk-in closet in walnut c. melamine with lateral side frame. Above: inner equipment in walnut c. melamine. Inner fumé glass shelves, piombo painted frame with built-in led lamps.



In questa pagina: interni nobilitato noce c. Ripiano nobilitato noce c. con frontale in alluminio verniciato piombo, illuminazione integrata led, tubo appendiabiti verniciato piombo. A destra: retro dell'anta Fitted con profilo alluminio verniciato piombo, barra retroanta rivestita in tecnopelle con ganci portacinture.



This page: back of Fitted door with piombo painted aluminium frame, bar covered in techno-leather with belt hooks. To the left: Inner structure in walnut c. melamine. Shelf in walnut c. with piombo mat painted aluminium front, built-in led lamps, piombo painted hanging rails.



In questa pagina: cabina armadio Senzafine nobilitato noce c. Zoccolo verniciato piombo. Ripiani nobilitato noce c. con frontale alluminio verniciato piombo. Contenitore porta camicie con ripiani interni rivestiti in tecnopelle 01 visone. Cassetti rivestiti in tessuto con frontale in tecnopelle 01 visone. Poltrona Santa Monica rivestimento in pelle Nabuk 5 grafite.

This page: Senzafine walk-in closet in walnut c. melamine. Plinth piombo painted. Shelves in walnut c. melamine with piombo painted aluminium front. Shirt storage with inner shelves covered in 01 visone techno-leather. Drawers covered in fabric with front in 01 visone techno-leather. Santa Monica armchair covered in 5 grafite Nabuk leather.





Nella pagina precedente: cabina armadio Senzafine nobilitato noce c. con fianchi telaio. Ripiani vetro fumé con telaio in alluminio verniciato piombo e illuminazione integrata led. In questa pagina: ripiani nobilitato noce c. con frontale alluminio verniciato piombo. Cassettiere con maniglia Track verniciato piombo, frontale in cristallo trasparente, fondo cassetti tecnopelle 01 visone.

Previous page: Senzafine walk-in closet in walnut c. melamine with lateral side frame. Shelves in fumé glass with piombo painted aluminium frame and built-in led lamps. This page: shelves in walnut c. melamine with piombo painted aluminium frame. Chest of drawers with piombo painted Track handles, transparent glass front, drawers bottom in 01 visone techno-leather.

Fitted armadi: ante e interni
 ante: Fitted apertura battente
 interni: nobilitato noce c.,
 tecnopelle 01 visone, verniciato piombo

A h 2590 p 609
 finitura: laccato opaco arena maniglie Volo
 verniciato piombo, vetro trasparente
 riflettente con telaio verniciato piombo
 e maniglia Fitted verniciato piombo

B h 2590 p 609
 finitura: laccato opaco arena maniglie Volo
 verniciato piombo

Senzafine cabina armadio h 2590 p 584
 finitura: nobilitato noce c.
 attrezzatura: nobilitato noce c., tecnopelle 01
 visone, verniciato piombo

Fitted wardrobes: doors and inner equipment
 doors: Fitted, leaf opening
 inner equipment: walnut c. melamine,
 01 visone techno-leather, piombo painted

A h 102" d 24"
 finishing: arena mat lacquered, piombo painted
 Volo handles, reflecting transparent glass with
 piombo painted frame and piombo painted
 Fitted handle

B h 102" d 24"
 finishing: arena mat lacquered, piombo painted
 Volo handles

Senzafine walk-in closet h 102" d 23"
 finishing: walnut c. melamine
 equipment: walnut c. melamine,
 01 visone techno-leather, piombo painted

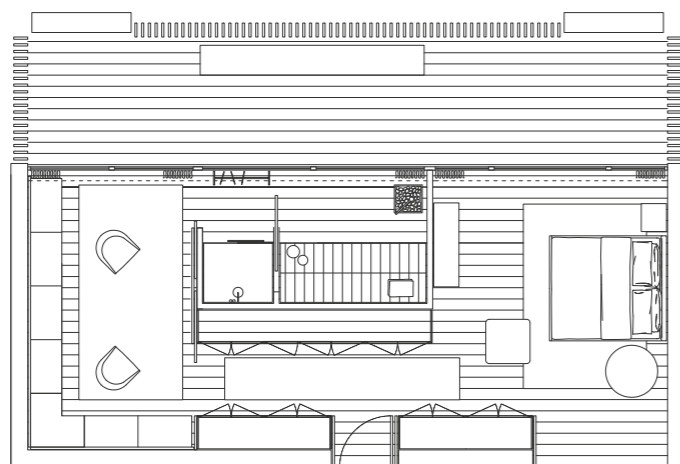

Fitted armadi/wardrobes design Rodolfo Dordoni

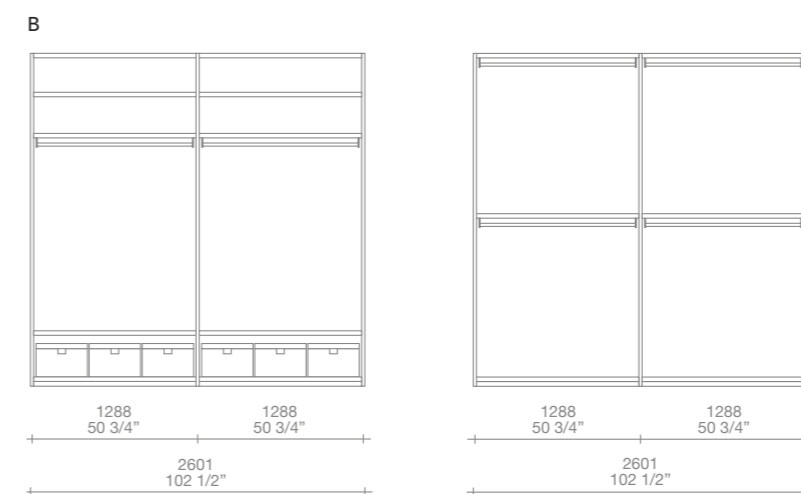
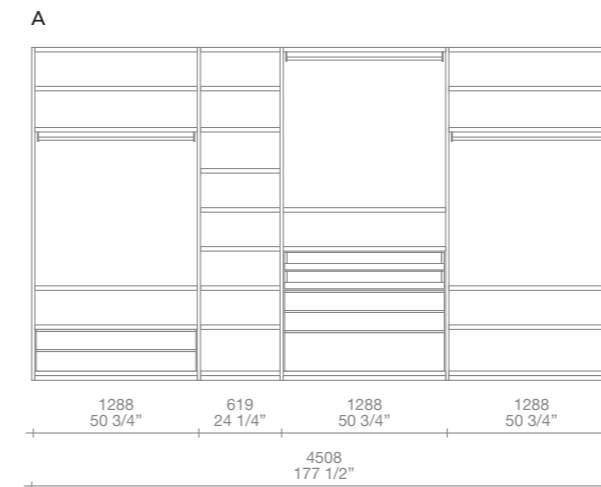

Senzafine cabina armadio/walk-in closet design Rodolfo Dordoni

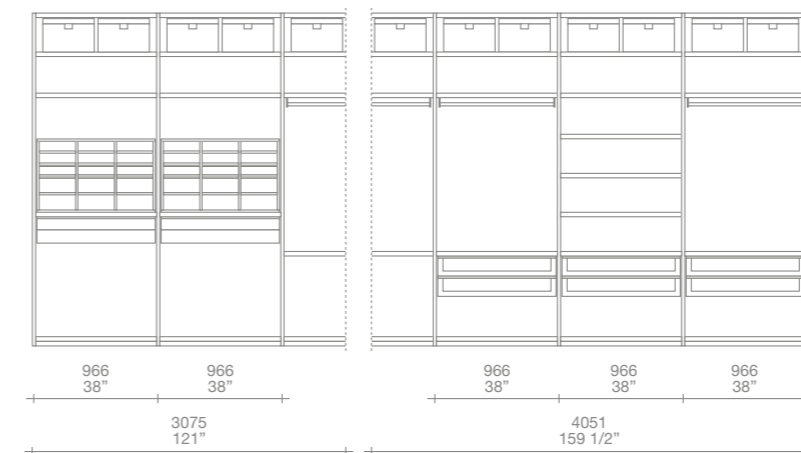

Arca letto
pelle sfoderabile Nabuk 1 latte

Tribeca tavolino
struttura metallo verniciato brown nickel opaco,
piano marmo calacatta oro

You comodino e cassettera
finitura rovere spessart

Santa Monica poltrona
pelle Nabuk 5 grafite

Onda pouf
tessuto sfoderabile Merida 04 lava

Dune pouf
tessuto sfoderabile Rabat 412 cemento

Arca bed
1 latte Nabuk removable leather

Tribeca coffee table
mat brown nickel painted metal structure,
calacatta oro marble top

You night table and chest of drawers
spessart oak

Santa Monica armchair
5 grafite Nabuk leather

Onda pouf
04 lava Merida removable fabric

Dune pouf
412 cemento Rabat removable fabric

Arca design Paolo Piva

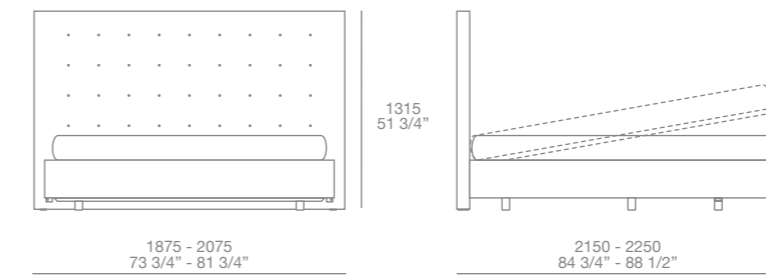

Tribeca design Jean-Marie Massaud

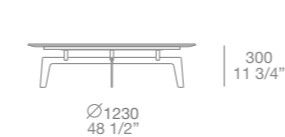

You design D. & T.

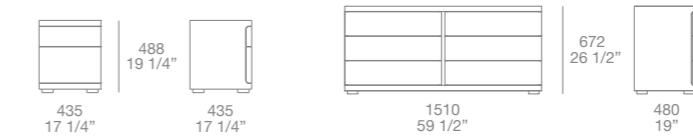

Santa Monica design Jean-Marie Massaud

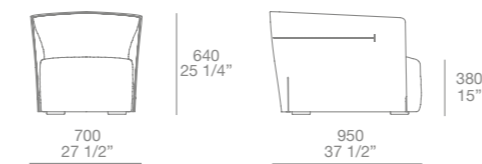

Onda design CR&S Poliform



Dune design Carlo Colombo



TECHNICAL DATA

SENZAFINE pag 220

armadi e cabina armadio / wardrobes and walk-in closet

UBIK pag 230

cabina armadio / walk-in closet

LETTI / BEDS COLLECTION pag 232

COMPLEMENTI NOTTE / NIGHT STORAGE UNITS pag 254

RETI / BEDSTEADS pag 266

MATERASSI / MATTRESSES pag 267

RIVESTIMENTI MATERASSI / MATTRESSES COVERS pag 270

GUANCIALI / PILLOWS pag 271

INSERTI PIUMINI / DUVETS pag 272

COLLEZIONE BIANCHERIA / LINEN COLLECTION pag 273

TAPPETI / CARPETS COLLECTION pag 274

FINITURE / FINISHINGS pag 276

Armadi, cabine, letti e contenitori notte. Elementi dal design contemporaneo e dalle linee essenziali, protagonisti di un linguaggio sofisticato che rende la cultura del saper fare protagonista di un lifestyle internazionale. Una panoramica completa della collezione, dai sistemi ai complementi, dalle attrezzature agli accessori, approfondita per ogni modello con dimensioni e descrizione delle caratteristiche principali. Un abaco delle finiture e dei materiali, selezionati per far parte di uno stile coordinato e armonico.

Wardrobes, walk-in closets and storage units. Contemporary design and essential lines are the protagonists of a sophisticated language that speaks of the culture of "know-how" for an international life style. An overview of the collections, from the systems to the furniture, up to the equipment and the accessories with the specification of the dimensions for each model and a description of their main features. This "abacus" of finishes and materials is selected to be part of a consistent and harmonious style.

SENZAFINE

armadi e cabina armadio / wardrobes and walk-in closet

TECHNICAL DATA

Un sistema armadi e una cabina armadio progettati con una modularità evoluta, in grado di inserirsi in ogni spazio.

La cabina armadio, design Rodolfo Dordoni, è caratterizzata dai fianchi di spessore mm 35, che ne sottolineano la solidità formale e il rigore geometrico. Il fianco a telaio permette invece di creare cabine armadio di grande leggerezza formale e di definire composizioni armadio caratterizzate dagli interni "aperti".

Il sistema Senzafine propone un'organizzazione evoluta degli interni.

Finiture: la struttura e l'attrezzatura del sistema Senzafine sono disponibili in nobilitato nei colori: artik bianco, larice bianco, rovere cenere, noce c. e rovere spessart.

Lavabile, di facile manutenzione, resistente all'umidità e ai graffi: l'impianto strutturale di ogni armadio Senzafine è pensato per garantire solidità e completa affidabilità nel tempo. Gli schienali e i fianchi a telaio sono disponibili anche in vetro: trasparente extrachiaro, trasparente riflettente, fumé e riflettente bronzato.

Soluzioni speciali: il sistema prevede tagli a misura in larghezza, altezza e profondità; fasce di tamponamento orizzontali e verticali; cambi di profondità; composizioni a ponte; passaggi porta; elementi terminali. Il programma permette di risolvere al meglio le situazioni d'angolo.

Senzafine cassettiere ad isola disponibili in 2 profondità e 3 altezze, profondità 584 con schienale finito sul retro, profondità 1131 con cassetti da entrambi i lati, attrezzabili con cassetti nobilitato e vetro, vassoi e vassoi portascarpe.

A wardrobes system and a walk-in closet with a contemporary modularity, suitable to any space.

The walk-in closet, design Rodolfo Dordoni, is distinguished by vertical panels of 1 1/2" that bring out the solidity of shapes and the geometry. The frame side allows to create great formal lightness walk-in closets and to realize wardrobes characterized by inner open units. Senzafine system proposes an advanced organization of the internal parts of the cabinets.

Finishings: the structure and the equipment of Senzafine system are available in the following melamine colours: white artik, white larch, cenere oak, walnut c. and spessart oak. It can be easily cleaned and maintained, it is resistant to humidity and to scratches: the structure of each Senzafine wardrobe is conceived to grant solidity and reliability for long time.

Backs and frame sides could be also in glass: transparent extra light, transparent reflecting, fumé and bronzed reflecting glass.

Special solutions: the system provides cuts on measure in width, height and depth; horizontal and vertical fillers; changes in depth; bridge wardrobes; door passages; end wardrobes.

The system allows to solve the corner situations in the best way.

Senzafine island chest of drawers Available in 2 depths and 2 heights, depth 23" with finished back panel, depth 44 1/2" with drawers on the both sides, they can be equipped with melamine and glass drawers, trays and shoe shelves.

DIMENSIONI / DIMENSIONS

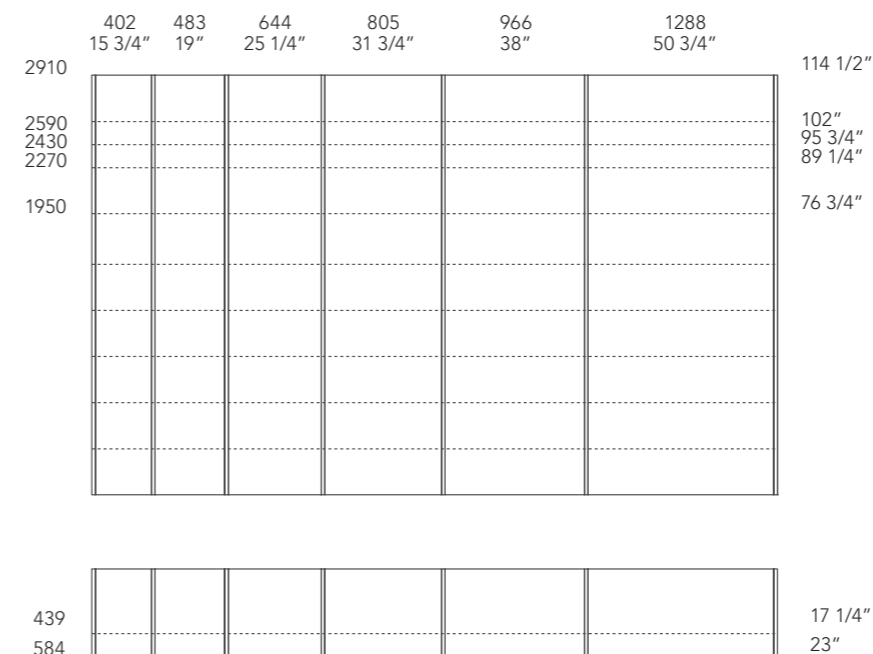

Armadi Senzafine

Per ottenere la larghezza totale, alla somma delle colonne aggiungere mm 25 per il fianco laterale.

Cabina armadio Senzafine

Per ottenere la larghezza totale, alla somma delle colonne aggiungere mm 35 per il fianco laterale e mm 10 per ogni altro fianco presente.

Senzafine wardrobe

To obtain the total width, add to the total columns 1" for the lateral side.

Senzafine walk-in closet

To obtain the total width, add to the total columns 1 1/2" for the lateral side and 1/2" for any other vertical panel of the closet.

TIPOLOGIE FIANCHI / SIDES RANGE

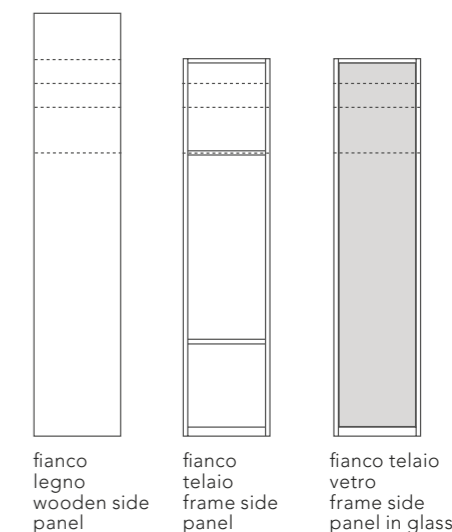

Fianco legno: profondità mm 439 e 584, spessore mm 35 per cabina armadio e mm 25 per armadi.

Fianco telaio e telaio vetro: profondità mm 584, spessore mm 25.

Wooden side panel: depth 17 1/4" and 23", thickness 1 1/2" for walk-in closet and 1" for wardrobes.

Frame side and glass frame: depth 23", thickness 1".

FINITURE STRUTTURA / STRUCTURE FINISHING



SENZAFINE
armadi / wardrobes

TECHNICAL DATA

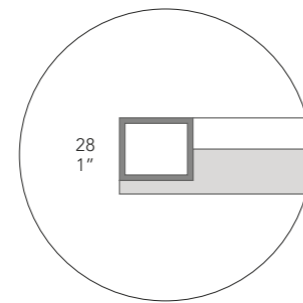

laccato / lacquered

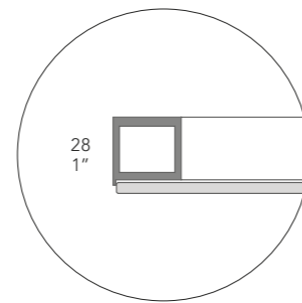

vetro / glass

FITTED design Rodolfo Dordoni
Apertura: battente. Finiture anta: laccato opaco colori, vetro trasparente extrachiario, vetro trasparente riflettente, riflettente bronzato e vetro fumè. Finiture profilo/maniglia alluminio: verniciato opaco piombo, laccato opaco colori e cromo nero. Possibilità anta con serratura.

pag 110-115-154/161-179/189-195-202/207
Opening: leaf door.
Door finishings: mat lacquered colours, transparent extralight glass, transparent reflecting glass, bronzed reflecting glass and fumé glass.
Aluminium handle/profile finishings: mat painted piombo, mat lacquered colours and black chrome.
Door also available with keylock.

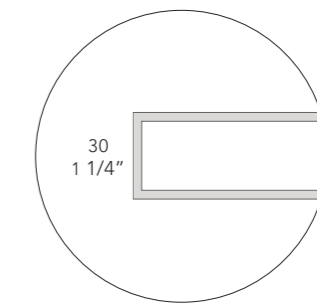

battente e coplanare
leaf and coplanar door

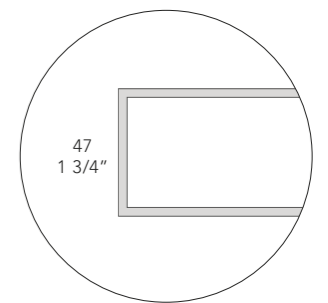

scorrevole
sliding door

BANGKOK design Operadesign
Apertura: battente, scorrevole e scorrevole coplanare.
Finiture anta: rivestita in cuoio.
Finiture profilo: cromato, verniciato opaco piombo o brown nickel opaco e lucido.

pag 12-28/33-125/132
Openings: leaf, sliding and coplanar sliding door.
Door finishings: covered in hide.
Handle profile finishings: chromed, mat painted piombo or mat and glossy brown nickel.

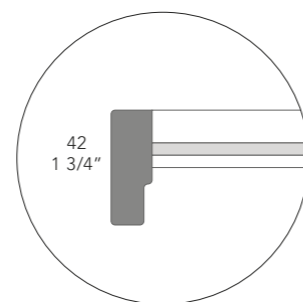

EGO design Giuseppe Bavuso
Apertura: battente.
Finiture anta: vetro trasparente extrachiario, vetro trasparente riflettente, riflettente bronzato e vetro fumè.
Finiture profilo/maniglia alluminio: verniciato opaco piombo, laccato opaco colori e cromo nero. Possibilità anta con serratura.

pag 29-30
Opening: leaf door.
Door finishings: transparent extralight glass, transparent reflecting glass, bronzed reflecting glass and fumé glass.
Aluminium handle/profile finishings: mat painted piombo, mat lacquered colours and black chrome.
Door also available with keylock.

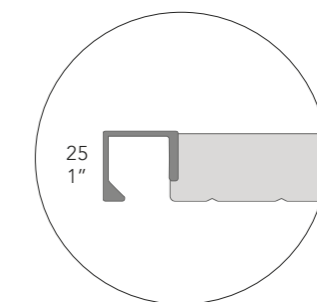

STRATUS design Giuseppe Bavuso
Apertura: battente, scorrevole e scorrevole coplanare.
Finiture anta: rovere laccato opaco colori e rovere spessart.
Finiture profilo/maniglia Rail alluminio: verniciato piombo e laccato opaco colori.

Openings: leaf, sliding and coplanar sliding door.
Door finishings: oak mat lacquered colours and spessart oak.
Aluminium handle/profile Rail finishings: painted piombo and mat lacquered colours.

SENZAFINE
armadi / wardrobes

TECHNICAL DATA

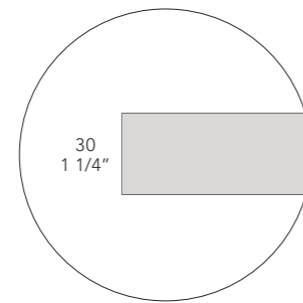

MADISON design Carlo Colombo
Apertura: battente.
Finiture anta: rovere laccato opaco colori,
rovere spessart e noce c.

Opening: leaf door.
Door finishings: oak mat lacquered colours,
spessart oak and walnut c.

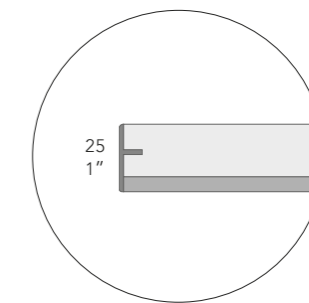

OCEAN design CR&S Poliform
Apertura: battente, scorrevole e scorrevole
complanare. Finiture anta: 7 colori vetro lucido e 6
colori vetro satinato, vetro riflettente blu; specchio
bianco. Finiture profilo alluminio: verniciato opaco
piombo, laccato opaco colori.

pag 108-113
Openings: leaf, sliding and coplanar sliding door.
Door finishings: 7 colours glossy glass and 6 co-
lours mat glass, blue reflecting glass; white mirror.
Aluminium profile finishings: mat painted piombo
and mat lacquered colours.

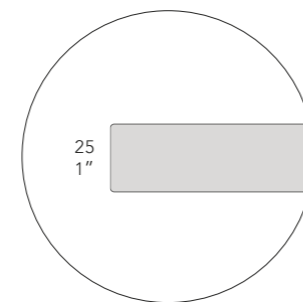

NEW ENTRY design CR&S Poliform
Apertura: battente, libro, scorrevole, scorrevole
complanare e cassetti.
Finiture anta: laccato opaco colori, laccato lucido
colori, rovere laccato opaco colori, rovere spessart
e noce c. Finitura rovere laccato opaco colori,
rovere spessart e noce c. solo nelle altezze mm
1950-2270-2430-2590.
Possibilità anta con serratura.

pag 75-84/87
Openings: leaf, folding, sliding and coplanar
sliding door and drawers.
Door finishings: mat lacquered colours, glossy
lacquered colours, oak mat lacquered colours,
spessart oak and walnut c.
The finishings oak mat lacquered colours,
spessart oak and walnut c. are available only for
the heights: 76 3/4" - 89 1/4" - 95 3/4" - 102".
Door also available with keylock.

SENZAFINE
armadi / wardrobes

TECHNICAL DATA

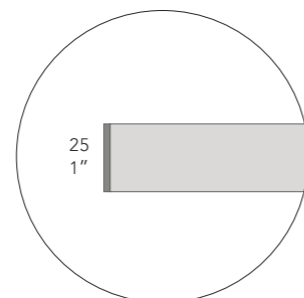

ARTIK design CR&S Poliform
Apertura: battente, libro, scorrevole, scorrevole complanare e cassetti.
Finiture anta: nobilitato Artik bianco 01, bordo ABS in tinta applicato al laser e nobilitato Artik laccato opaco colori.
Possibilità anta con serratura.

Openings: leaf, folding, sliding and coplanar sliding door and drawers.
Door finishings: Artik melamine in the colour bianco 01, with laser applied abs edge same colour and Artik melamine mat lacquered colours.
Door also available with keylock.

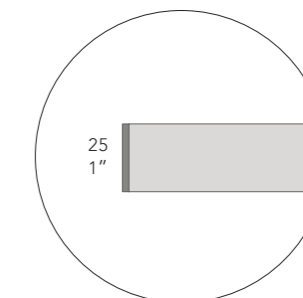

SAND design CR&S Poliform
Apertura: battente, libro, scorrevole, scorrevole complanare e cassetti.
Finiture anta: nobilitato pino bianco, bordo ABS in tinta applicato al laser; nobilitato pino laccato opaco colori, nobilitato noce c., nobilitato rovere spessart, nobilitato larice bianco e nobilitato rovere cenere.
Possibilità anta con serratura.

Openings: leaf, folding, sliding and coplanar sliding door and drawers.
Door finishings: white pine melamine, with laser applied abs edge same colour; mat lacquered colours pine melamine, walnut c. melamine, spessart oak melamine, white larch melamine and cenere oak melamine.
Door also available with keylock.

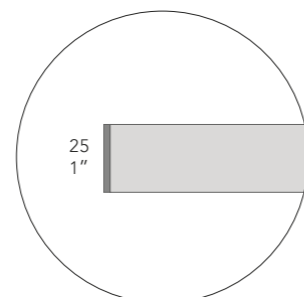

CLUB design CR&S Poliform
Apertura: battente, libro, scorrevole e cassetti.
Finiture anta: nobilitato Club nei colori bianco 01, canapa 35, ghiaccio 60, bordo ABS in tinta applicato al laser; acrilico lucido bianco 01 e canapa 35 (acrilico solo battente, libro e cassetti esterni).
Possibilità anta con serratura.

Openings: leaf, folding and sliding door and drawers.
Door finishings: Club melamine in the colours bianco 01, canapa 35, ghiaccio 60, with laser applied abs edge same colour; acrylic glossy bianco 01 and canapa 35 (acrylic only for leaf door, folding door and external drawers).
Door also available with keylock.

SENZAFINE
armadi / wardrobes

TECHNICAL DATA

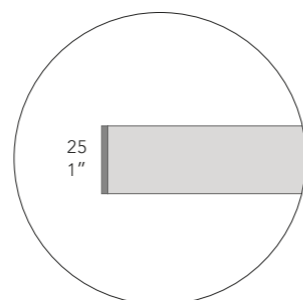

SURF design Carlo Colombo
Apertura: battente, libro, scorrevole, scorrevole complanare e cassetti.
Finiture anta: nobilitato Surf bianco 01, bordo ABS in tinta applicato al laser e nobilitato Surf laccato opaco colori.
Possibilità anta con serratura.

Openings: leaf, folding, sliding and coplanar sliding door and drawers.
Door finishings: Surf bianco 01 melamine, with laser applied abs edge same colour and Surf mat lacquered colours.
Door also available with keylock.

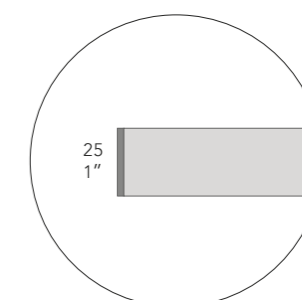

GRAFFITI design Carlo Colombo
Apertura: battente, libro, scorrevole, scorrevole complanare e cassetti.
Finiture anta: nobilitato Graffiti nei colori bianco 01, canapa 35, ghiaccio 60, bordo ABS in tinta applicato al laser.
Possibilità anta con serratura.

Openings: leaf, folding, sliding and coplanar sliding door and drawers.
Door finishings: Graffiti melamine in the colours bianco 01, canapa 35, ghiaccio 60, with laser applied abs edge same colour.
Door also available with keylock.

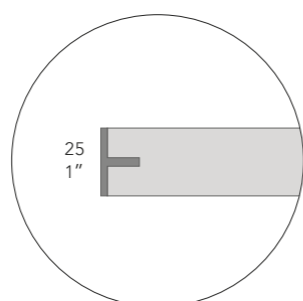

SKIN design CR&S Poliform
Apertura: battente, scorrevole e scorrevole complanare.
Finiture anta: nobilitato Skin laccato opaco colori e laccato opaco 5 colori: 92 elefante, 93 moro, 96 senape, 95 mattone, 94 latte.
Finiture profilo/maniglia alluminio: verniciato opaco piombo e laccato opaco colori.
Possibilità anta con serratura.

pag 50-54
Openings: leaf, sliding and coplanar sliding door.
Door finishings: melamine Skin mat lacquered 27 colours + 5 colours: 92 elefante, 93 moro, 96 senape, 95 mattone, 94 latte.
Aluminium handle/profile finishings: mat painted piombo and mat lacquered colours.
Door also available with keylock.

UBIK

cabina armadio / walk-in closet

TECHNICAL DATA

Ubik è un sistema di pannellature che rivestono le pareti, completate da un'ampia varietà di attrezzature.

Le pannellature schienale portante sono comprensive di cremagliera per il fissaggio a muro e per il posizionamento delle attrezzature.

La possibilità di posizionare le attrezzature all'altezza desiderata conferma la flessibilità del sistema.

La pannellatura schienale, può essere sostituita da profili con cremagliera, fissati a muro e completati dall'attrezzatura.

Finiture: i pannelli e le attrezzature del sistema Ubik sono disponibili in nobilitato in 4 finiture: artik bianco, rovere cenere, noce c. e rovere spessart.

I pannelli sono disponibili anche in 7 colori per il vetro lucido, in specchio bianco e in nobilitato Skin laccato opaco colori e laccato opaco 5 colori: 92 elefante, 93 moro, 96 senape, 95 mattone, 94 latte.

pag 49/59-134/140

Ubik is a system of wall panelling completed by a wide variety of equipments.

The self-bearing panels include the metal frame for wall fitting and for equipments positioning.

The possibility of a free positioning in height of the equipment confirms the flexibility of the system.

The wall mounted panels can be replaced by wall fitted metal profiles which can be completed by the equipments.

Finishings: wall panels and equipment of Ubik are available in 4 different melamine colours: white artik, cenere oak, walnut c. and spessart oak.

Wall panels are also available in the 7 glossy glass colours, in white mirror and in melamine Skin mat lacquered 27 colours + 5 colours: 92 elefante, 93 moro, 96 senape, 95 mattone, 94 latte.

DIMENSIONI / DIMENSIONS

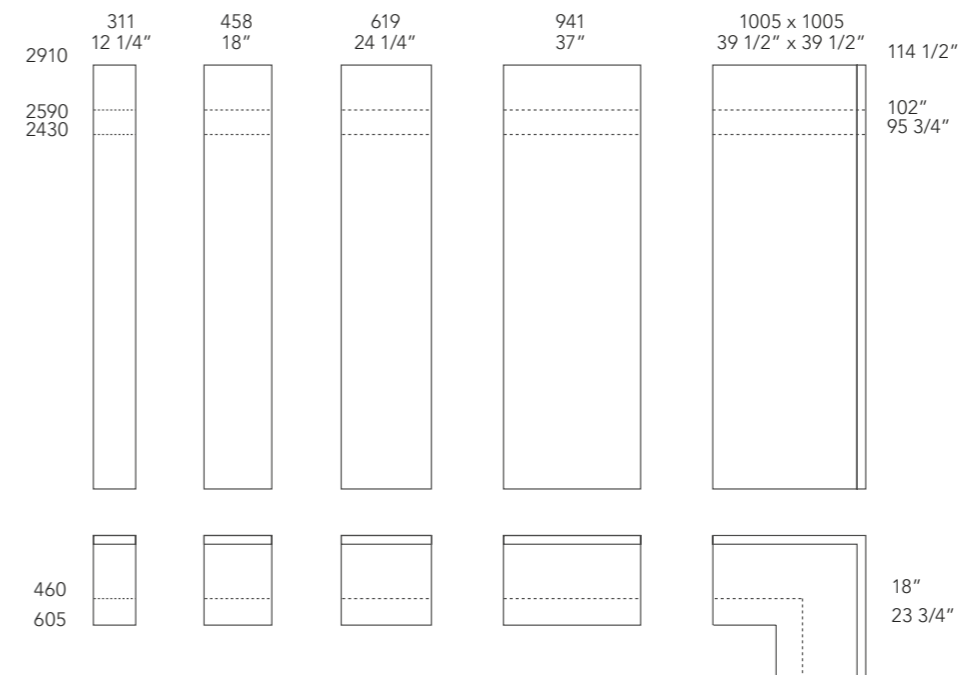

I pannelli sono disponibili in 3 altezze e 4 larghezze; spessore mm 60. Per ottenere la larghezza totale, alla somma dei pannelli aggiungere mm 32 (profilo terminale) e mm 4 tra ogni pannello. The back panels are available in 3 heights and 4 widths; thickness 2 1/4". To obtain the total width, add to the total panels 1 1/4" (end profil) and 1/4" between each panel.

Per la profondità mm 406 sono disponibili top, ripiani e basamenti. Ripiani disponibili anche l 1564 - 1886. Top, shelves and bases are also available for the depth 16". Shelves available also in w 61 1/2" - 74 1/4".

FINITURE PANNELLATURA E ATTREZZATURA / PANELLING AND EQUIPMENT FINISHINGS



FINITURE PANNELLATURA / PANELLING FINISHINGS



LETTI / BEDS

TECHNICAL DATA



KELLY design Emmanuel Gallina
Giroletto in legno massello, finiture rovere spessart e olmo nero, parte interna rivestimento sfoderabile in tessuto e non sfoderabile in pelle. Testata imbottita, rivestimento sfoderabile in tessuto e non sfoderabile in pelle e pelle Nabuk intrecciata. Possibilità di rivestimento testata di diverso materiale tra interno ed esterno.

pag 12
Bedframe in solid wood finishing spessart oak and black elm. Upholstered inner part covered in removable fabric and non-removable leather. Upholstered headboard covered in removable fabric and non-removable leather and woven Nabuk leather. Available with inner and outer covering in two different materials.

predisposto per materassi / for mattresses
l 1600-1800 x p 2000 - w 63"-70 3/4" x d 78 3/4"
Queen size l 1694 x p 2332 - w 66 3/4" x d 91 3/4"
predisposto per materassi / for mattresses
l 1525 x p 2030 - w 60" x d 80"
King size l 2100 x p 2332 - w 82 3/4" x d 91 3/4"
predisposto per materassi / for mattresses
l 1930 x p 2030 - w 76" x d 80"

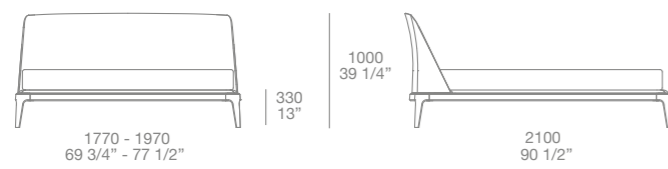

REVER design Rodolfo Dordoni
Giroletto e testata imbottite con rivestimento sfoderabile in tessuto e pelle. Nella versione in tessuto testata e giretto con fasce in pelle Nabuk non lavabili. Testata trapuntata con cucitura a cordoncino con un leggero contrasto di colore. Nella versione in pelle la testata presenta delle cuciture supplementari. Possibilità di base con contenitore e rete ribaltabile.

pag 40
Upholstered bed frame and headboard covered with removable fabric and leather. In the version with fabric covering headboard and bed frame with bands in leather Nabuk, non-washable. Quilted headboard with drawstring stitching with a light contrast in the colour. In the version with leather covering the headboard has additional stitching. Possibility of bed frame with container with lift up bedstead.

predisposto per materassi / for mattresses
l 1800 -2000 x p 2000 - w 70 3/4"-78 3/4" x d 78 3/4"
King size l 2815 x p 2425 - w 71 1/2" x d 95 1/2"
predisposto per materassi / for mattresses
l 1930 x p 2030 - w 76" x d 80"

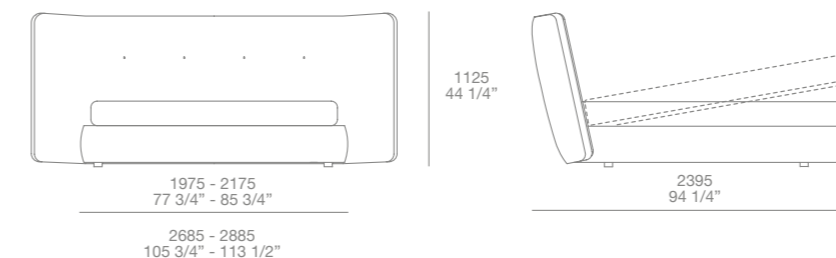

LETTI / BEDS

TECHNICAL DATA



LAZE design Rodolfo Dordoni

Giroletto e testata imbottite con rivestimento sfoderabile in tessuto e pelle. Possibilità retro testata in tela nera. Possibilità base con contenitore e rete ribaltabile.

pag 170

Upholstered bed frame and headboard covered in removable fabric and leather. Possibility of headboard backside covered with black canvas. Base with storage and lift-up bedstead also available.

predisposto per materassi / for mattresses
 I 1600-1800 x p 2000 - w 63"-70 3/4" x d 78 3/4"

King size I 2080 x p 2230 - w 82" x d 87 3/4"
predisposto per materassi / for mattresses
 I 1930 x p 2030 - w 76" x d 80"

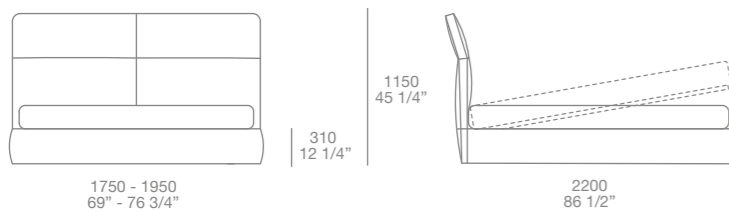

JACQUELINE design Jean-Marie Massaud

Giroletto e testata imbottite con rivestimento sfoderabile in tessuto e pelle. Cucitura normale doppia o cuciture a cordoncino con filato a 8 colori da campionario (escluso rivestimento velluto e pelle). Possibilità base con contenitore e rete ribaltabile.

pag 88

Upholstered bed frame and headboard covered in removable fabric and leather. Double normal stitch or drawstring stitching cord in 8 colours as per sample book. (except velvet and leather covering). Base with storage and lift-up bedstead also available.

predisposto per materassi / for mattresses
 I 1000-1600-1800 x p 2000-2100
 w 39 1/4"-63"-70 3/4" x d 78 3/4"-82 3/4"

Queen size I 1804 x p 2187 - w 71" x d 86"
predisposto per materassi / for mattresses
 I 1525 x p 2030 - w 60" x d 80"

King size I 2210 x p 2187 - w 87" x d 86"
predisposto per materassi / for mattresses
 I 1930 x p 2030 - w 76" x d 80"

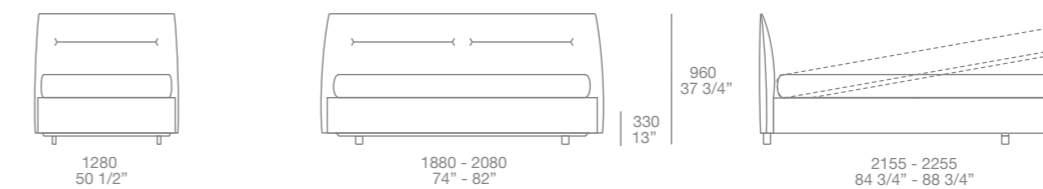



DREAM design Marcel Wanders
Giroletto con testata o con pannellatura a muro.
Giroletto e testata imbottite con rivestimento sfoderabile in tessuto e pelle.
Possibilità base con contenitore e rete ribaltabile.
Pannellatura a muro con rivestimento sfoderabile in tessuto e pelle. Il sistema di pannelli può essere utilizzato per comporre, oltre alla testata del letto, anche una boiserie, completata da mensole nelle finiture laccato opaco colori, laccato lucido colori e noce c. o da specchi a parete.

pag 66-72
Bed frame with headboard or with wall mounted panels. Upholstered bed frame and headboard covered in removable fabric and leather.
Base with storage and lift-up bedstead also available. Wall panelling covered in removable fabric and leather.
The panels can be used to compose an headboard or a wall panelling which can be completed by shelves in the finishings mat lacquered colours, glossy lacquered colours and walnut c. or with wall mirrors.

predisposto per materassi / for mattresses
l 1600-1800 x p 2000-2100
w 63"- 70 3/4" x d 78 3/4"- 82 3/4"



pannelli l 690 solo con materasso l 1800
panels w 27 1/4" only with mattress w 70 3/4"

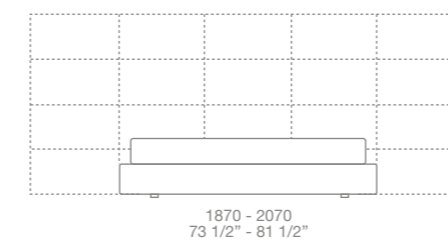

pannelli l 955 per materasso l 1600 - pannelli l 1037 per materasso l 1800
panels w 37 1/2" for mattress w 63" - panels w 40 3/4" for mattress w 70 3/4"

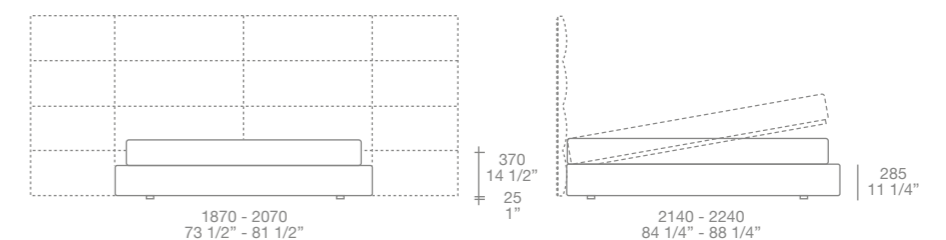

pannelli a muro per testata o boiserie
wall panels for headboard or wall panelling



mensole in stratificato
layered shelves



specchio a muro
wall mirror

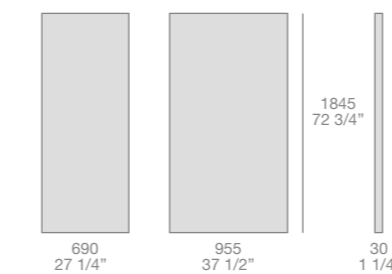

abbinamento specchio pannelli a muro
combination of wall panels and mirror

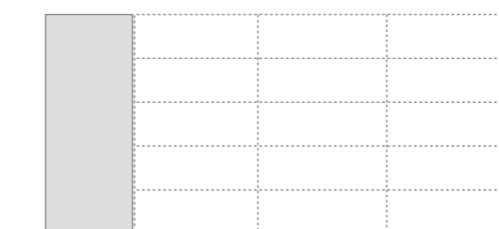

LETTI / BEDS

TECHNICAL DATA



IPANEMA design Jean-Marie Massaud
 Testata con rivestimento sfoderabile in tessuto e non sfoderabile in pelle, fianchi in rovere spessart con mostrine laterali nella stessa finitura della testata non sfoderabili. Giroletto interno con rivestimento in tessuto e pelle, struttura esterna in rovere spessart.

Headboard with removable fabric covering and non-removable leather covering, headboard sides in spessart oak with fastening details in the same finishing of the headboard, non-removable. Inner bed frame with fabric or leather covering, external frame in spessart oak.

predisposto per materassi / for mattresses
 l 1600-1800 x p 2000 - w 63"-70 3/4" x d 78 3/4"
King size l 2260 x p 2245 - w 89" x d 88 1/2"
predisposto per materassi / for mattresses
 l 1930 x p 2030 - w 76" x d 80"

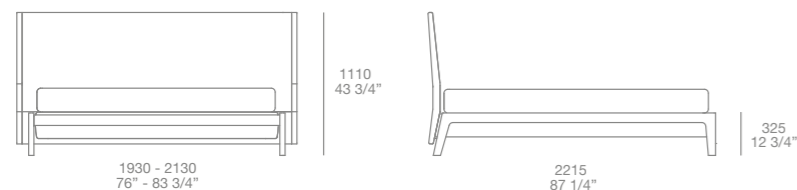

IPANEMA design Jean-Marie Massaud
 Testata con rivestimento sfoderabile in tessuto e non sfoderabile in pelle, fianchi in rovere spessart con mostrine laterali nella stessa finitura della testata non sfoderabili. Giroletto interno con rivestimento in tessuto e pelle, struttura esterna in rovere spessart. Comodino integrato nella testata con piano rovere spessart e cassetto girevole struttura verniciato opaco brown nickel e fondo interno cassetto in cuoio caffè.

Headboard with removable fabric covering and non-removable leather covering, headboard sides in spessart oak with fastening details in the same finishing of the headboard, non-removable. Inner bed frame with fabric or leather covering, external frame in spessart oak. Night table integrated in the headboard with top in spessart oak and swivel drawer with brown nickel mat lacquered structure and inner bottom in hide caffè.

predisposto per materassi / for mattresses
 l 1600-1800 x p 2000 - w 63"-70 3/4" x d 78 3/4"
King size l 3250 x p 2245 - w 128" x d 88 1/2"
predisposto per materassi / for mattresses
 l 1930 x p 2030 - w 76" x d 80"

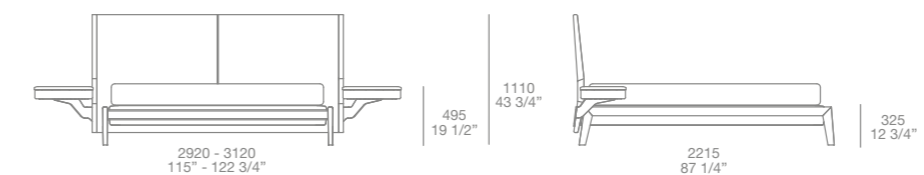

LETTI / BEDS

TECHNICAL DATA



BRUCE design Jean-Marie Massaud
 Testata imbottita in tessuto sfoderabile con profilo in gros-grain 8 colori da campionario, possibilità di inserto in differente tessuto. Base letto imbottita, sfoderabile in tessuto e pelle. Possibilità base con contenitore e rete ribaltabile.

pag 98
 Upholstered headboard covered in removable fabric with stitching cord in 8 colours as per sample book, possibility of the insert in a different fabric. Upholstered bed frame, covered in removable fabric and leather. Base with storage and lift-up bedstead also available.

predisposto per materassi / for mattresses
 l 1000-1600-1800 x p 2000-2100
 w 39 1/4"-63"-70 3/4" x d 78 3/4"-82 3/4"

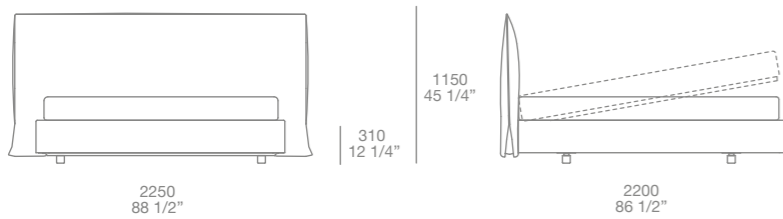

ONDA design Paolo Piva
 Giroletto e testata imbottiti con rivestimento tesato non sfoderabile in pelle. Piedini cromati o verniciati opaco brown nickel.

pag 123
 Upholstered bed frame and headboard with stretched covering in non-removable leather. Chromed or painted brown nickel mat feet.

predisposto per materassi / for mattresses
 l 1600-1800 x p 2000
 w 63"-70 3/4" x d 78 3/4"



LETTI / BEDS

TECHNICAL DATA



ARCA BED SYSTEM design Paolo Piva
Testata alta imbottita trapuntata con rivestimento sfoderabile in tessuto e pelle, da abbinare alle 2 basi previste: base imbottita e sommier. Possibilità di retro testata in tela nera. Base imbottita e sommier con rivestimento sfoderabile in tessuto e pelle. Possibilità per base imbottita di contenitore con rete ribaltabile.

pag 196
High quilted upholstered headboard covered in removable fabric and leather to be combined with 2 frame typologies: upholstered base and bed base. Possibility of headboard backside covered with black canvas. Upholstered base and bed base with removable covering in fabric and leather. Upholstered base is available also with container box with tip-up bedstead.

base imbottita predisposta per materassi
 l 1600-1800 x p 2000-2100
 upholstered base for mattresses
 w 63"- 70 3/4" x d 78 3/4"-82 3/4"

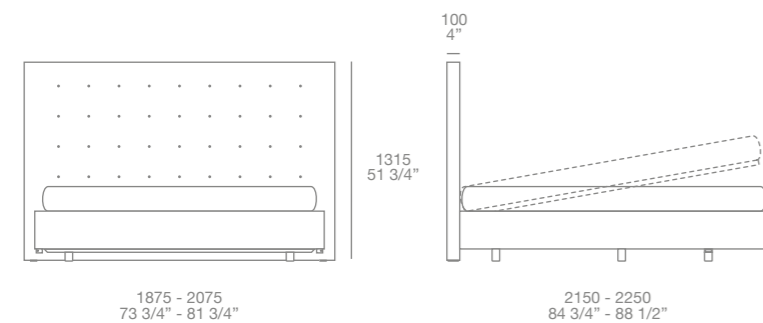

Le profondità indicate sono relative alle testate abbinata alla base imbottita; se abbinata alla base sommier togliere 20 mm.

The indicated depths refer to headboard combined with upholstered base; in case of headboard combined with bed base 20 mm must be deducted from the total depth.



ARCA BED SYSTEM design Paolo Piva
Testata imbottita trapuntata con rivestimento sfoderabile in tessuto e pelle da abbinare alle 2 basi previste: base imbottita e sommier. Possibilità di retro testata in tela nera. Base imbottita e sommier con rivestimento sfoderabile in tessuto e pelle. Possibilità per base imbottita di contenitore con rete ribaltabile.

Quilted upholstered headboard covered in removable fabric and leather to be combined with 2 frame typologies: upholstered base and bed base. Possibility of headboard backside covered with black canvas. Upholstered base and bed base with removable covering in fabric and leather. Upholstered base is available also with container box with tip-up bedstead.

base imbottita predisposta per materassi
 l 1000-1400-1600-1800-2000 x p 2000-2100
 upholstered base for mattresses
 w 39 1/4"-55"-63"-70 3/4"-78 3/4" x d 78 3/4"-82 3/4"

Queen size l 1638 x p 2190 - w 64 1/2" x d 86 1/4"
predisposto per materassi / for mattresses
 l 1525 x p 2030 - w 60" x d 80"

King size l 2044 x p 2190 - w 80 1/2" x d 86 1/4"
predisposto per materassi / for mattresses
 l 1930 x p 2030 - w 76" x d 80"

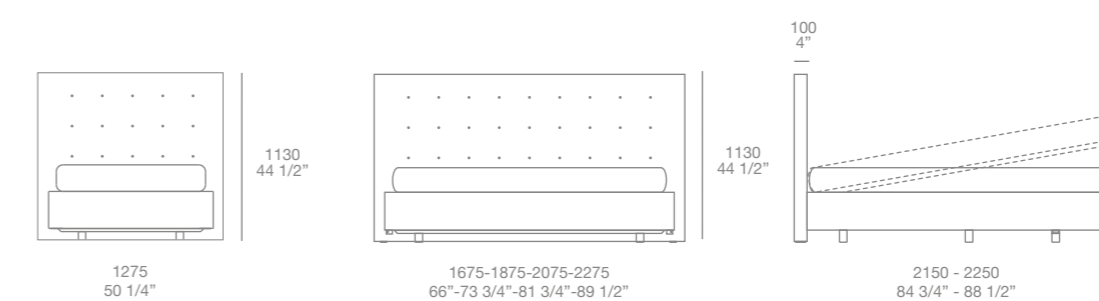

Le profondità indicate sono relative alle testate abbinata alla base imbottita; se abbinata alla base sommier togliere 20 mm.

The indicated depths refer to headboard combined with upholstered base; in case of headboard combined with bed base 20 mm must be deducted from the total depth.

LETTI / BEDS

TECHNICAL DATA



ARCA BED SYSTEM design Paolo Piva
Testata imbottita con rivestimento sfoderabile in tessuto e pelle da abbinare alle 2 basi previste: base imbottita e sommier.
 Possibilità di retro testata in tela nera.
 Base imbottita e sommier con rivestimento sfoderabile in tessuto e pelle.
 Possibilità per base imbottita di contenitore con rete ribaltabile.

Upholstered headboard covered in removable fabric and leather to be combined with 2 frame typologies: upholstered base and bed base.
 Possibility of headboard backside covered with black canvas.
 Upholstered base and bed base with removable covering in fabric and leather.
 Upholstered base is available also with container box with tip-up bedstead.

base imbottita predisposta per materassi
 l 1000-1400-1600-1800-2000 x p 2000-2100
 upholstered base for mattresses
 w 39 1/4"-55"-63"-70 3/4"-78 3/4" x d 78 3/4"-82 3/4"

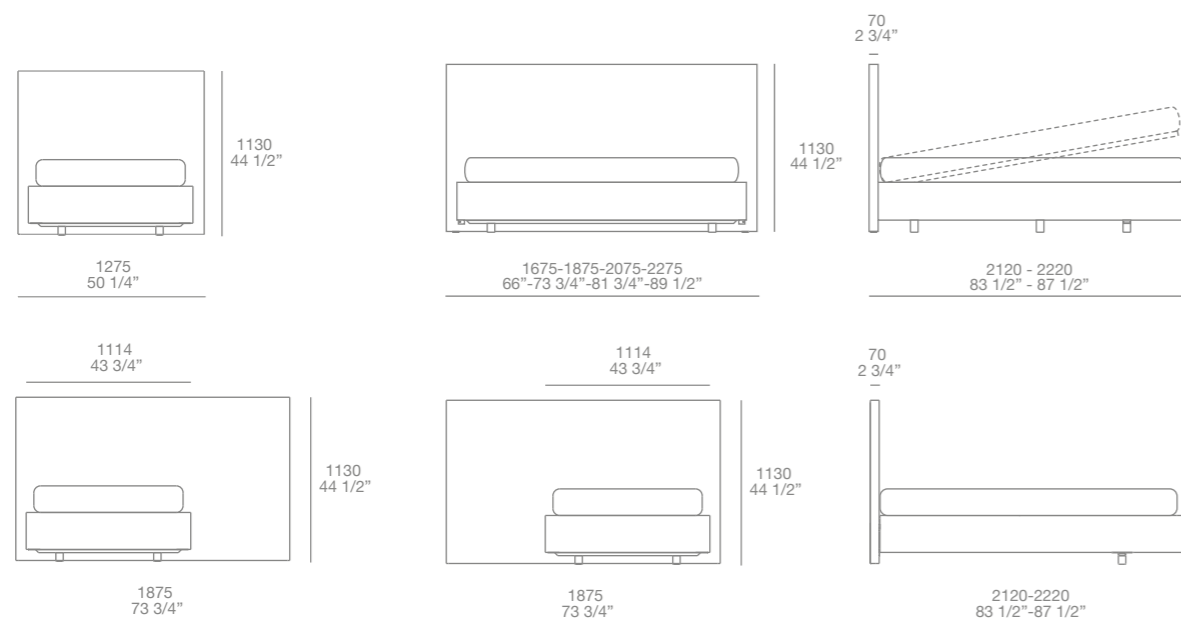

Le profondità indicate sono relative alle testate abbinare alla base imbottita; se abbinare alla base sommier togliere 20 mm.

The indicated depths refer to headboard combined with upholstered base; in case of headboard combined with bed base 20 mm must be deducted from the total depth.



ARCA BED SYSTEM design Paolo Piva
Testata imbottita reclinabile con rivestimento sfoderabile in tessuto e pelle da abbinare alle 2 basi previste: base imbottita e sommier.
 Base imbottita e sommier con rivestimento sfoderabile in tessuto e pelle.
 Possibilità per base imbottita di contenitore con rete ribaltabile.

Upholstered reclining headboard covered in removable fabric and leather to be combined with 2 frame typologies: upholstered base and bed base.
 Upholstered base and bed base with removable covering in fabric and leather.
 Upholstered base is available also with container box with tip-up bedstead.

base imbottita predisposta per materassi
 l 1600-1800 x p 2000-2100
 upholstered base for mattresses
 w 63"-70 3/4" x d 78 3/4"-82 3/4"

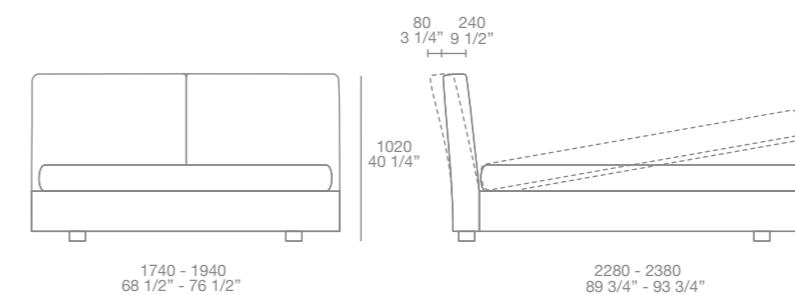

LETTI / BEDS

TECHNICAL DATA



ARCA BED SYSTEM design Paolo Piva
Base imbottita 4 lati con rivestimento
sfoderabile in tessuto e pelle.

Upholstered bed base 4 sides covered
in removable fabric and leather.

base imbottita predisposta per materassi
l 1000-1400-1600-1800-2000 x p 2000-2100
upholstered base for mattresses
w 39 1/4"-55"-63"-70 3/4"-78 3/4" x d 78 3/4"-82 3/4"

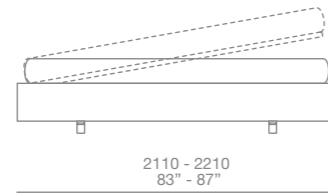
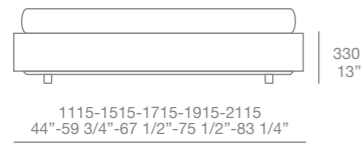

LETTI / BEDS

TECHNICAL DATA



PARK design Carlo Colombo
 Testata con rivestimento sfoderabile in tessuto e pelle. Giroletto in alluminio verniciato brown nickel opaco e lucido o laccato opaco colori.

Headboard with removable covering in fabric and leather. Bed frame in painted mat and glossy brown nickel or mat lacquered colours aluminium.

predisposto per materassi / for mattresses
 l 1600-1800 x p 2000
 w 63"-70 3/4" x d 78 3/4"

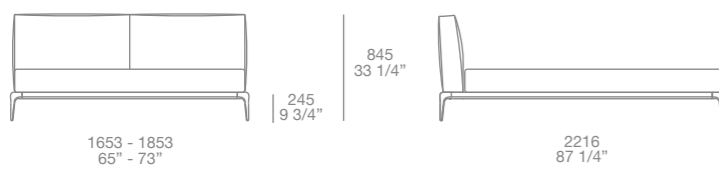

MEMO DUE design Carlo Colombo
 Giroletto e testata in legno, finitura laccato opaco colori.

Wooden bedframe and headboard, finishing mat lacquered colours.

predisposto per materassi / for mattresses
 l 1600-1800 x p 2000
 w 63"-70 3/4" x d 78 3/4"



LETTI / BEDS

TECHNICAL DATA



BOLTON design Giuseppe Viganò
Giroletto e testata imbottite con rivestimento; testata sfoderabile in tessuto, non sfoderabile in pelle; Giroletto sempre sfoderabile. Possibilità base con contenitore e rete ribaltabile. Disponibile con testata fissa o con meccanismo sali-scendi regolabile in due altezze.

pag 148
Upholstered bed frame and headboard covered in removable fabric, non removable in leather. Bed frame always removable. Base with storage and lift-up bedstead also available. Available with fix headboard or adjustable in height in two positions.

predisposto per materassi / for mattresses
l 1600-1800 x p 2000-2100
w 63"-70 3/4" x d 78 3/4"-82 3/4"

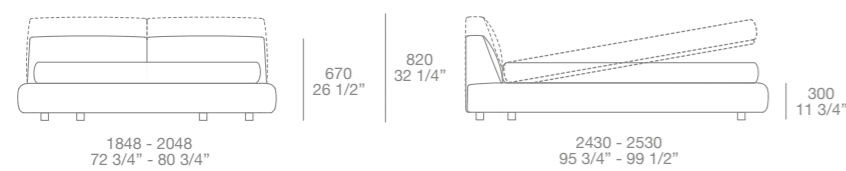

TEO design Paolo Piva
Laccato opaco colori, noce c. e rovere spessart o completamente rivestito in tessuto sfoderabile e non sfoderabile in pelle e cuoio.

Mat lacquered colours, walnut c. and spessart oak or completely covered in removable fabric and non-removable in leather and hide.

predisposto per materassi / for mattresses
l 1600-1800 x p 2000-2100
w 63"-70 3/4" x d 78 3/4"-82 3/4"

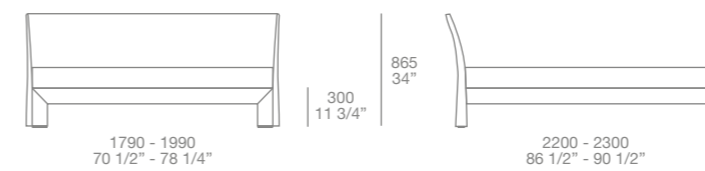

LETTI / BEDS

TECHNICAL DATA



BIG BED design Paola Navone
Giroletto e testata imbottite con rivestimento sfoderabile in tessuto e pelle. Disponibile con bracciolo dx o sx o senza bracciolo. Possibilità base con contenitore e rete ribaltabile.

Upholstered bed frame and headboard covered in removable fabric and leather.
Available with right or left arm or without arm.
Base with storage and lift-up bedstead also available.

predisposto per materassi / for mattresses
l 1600-1800 x p 2000
w 63"-70 3/4" x d 78 3/4"

con bracciolo sx-dx
with left-right arm

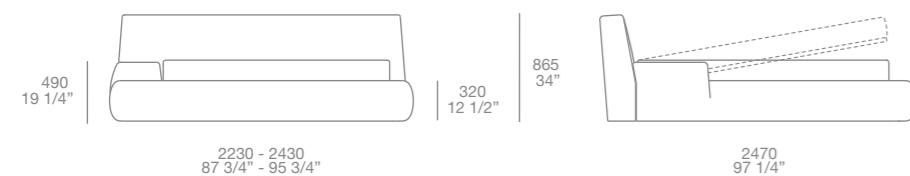

BIG BED design Paola Navone
Giroletto e testata imbottite con rivestimento sfoderabile in tessuto e pelle. Possibilità base con contenitore e rete ribaltabile.

Upholstered bed frame and headboard covered in removable fabric and leather.
Base with storage and lift-up bedstead also available.

predisposto per materassi / for mattresses
l 1600-1800 x p 2000 - w 63"-70 3/4" x d 78 3/4"

senza bracciolo
without arm

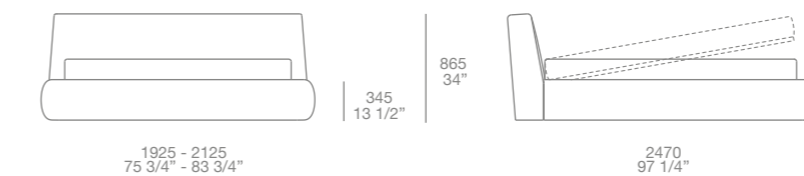

CONTENITORI / CONTAINERS

TECHNICAL DATA



KELLY design Emmanuel Gallina

Struttura rovere spessart e olmo nero, top laccato opaco colori, laccato lucido colori, cuoio o 4 marmi levigati e 5 lucidi (escluso emperador dark). Piedini verniciato brown nickel opaco e lucido. Solo per comò primo cassetto con fondo rivestito in cuoio e attrezzato con griglia divisoria portaoggetti.

pag 11-19

Structure in spessart oak and black elm, top in mat lacquered colours, glossy lacquered colours, hide or 4 mat and 5 glossy marble finishings (marble emperador dark not available). Mat and glossy brown nickel painted feet. Only for the chest of drawers the first upper drawer is available with hide covered bottom and accessorized with partition grid.

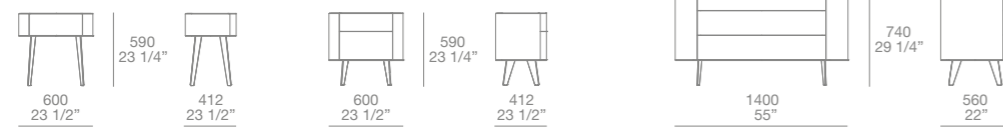

GIÒ design Rodolfo Dordoni

Struttura in olmo nero, top laccato lucido colori o cuoio, solo per comodino top superiore vetro trasparente extrachiario 2000. Solo per comò gola e fianchi interni verniciato brown nickel opaco e lucido, fondi cassetti rivestiti in tecnopelle.

pag 102-106

Structure in black elm, glossy lacquered or hide covered top, only for night table top in extralight transparent glass 2000. Only for chest of drawers handle profile and inner part of the sides in the finishings painted mat and glossy brown nickel, drawers bottom covered in techno-leather.

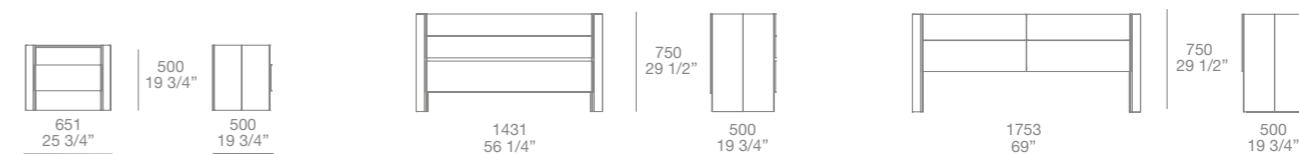

CONTENITORI / CONTAINERS

TECHNICAL DATA



PANDORA design Jean-Marie Massaud
Struttura e facciate laccato opaco colori, laccato lucido colori e rovere spessart. La struttura può avere una finitura diversa dai frontali. Interno cassetti in nobilitato rovere spessart con profili laccato opaco colori. Piedini verniciato brown nickel opaco e lucido.

Mat lacquered colours, glossy lacquered colours and spessart oak structure and fronts. The finishing of the structure could be different from the structure of the fronts. Mat lacquered colours inner. Drawer inner structure only in spessart oak melamine with profiles in mat lacquered colours. Mat and glossy brown nickel painted feet.

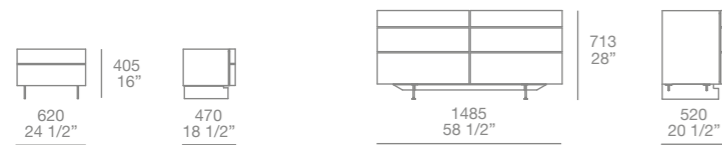

ONDA design CR&S Poliform
Struttura noce c., rovere spessart e solo per i comodini laccato opaco colori.
Piano: noce c., rovere spessart, cuoio, 5 marmi levigati e 6 lucidi e solo per i comodini laccato opaco colori. Maniglie cuoio.

pag 123-169-176
Structure in walnut c., spessart oak. Just for the night tables, mat lacquered colours.
Top in walnut c., spessart oak, hide, 5 mat and 6 glossy marbles. Just for the night tables, mat lacquered colours.
Handles in hide 10 colours.

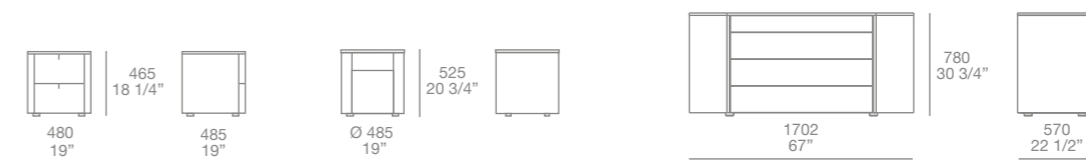

CONTENITORI / CONTAINERS

TECHNICAL DATA



ABBINABILI design CR&S Poliform

Laccato opaco colori, laccato lucido colori, rovere spessart e noce c. Settimanale con 4 cassetti e ribalta attrezzata, interno ribalta finitura noce dogato per laccati, laccato opaco moka per rovere spessart e noce c.

pag 150

Mat lacquered colours, glossy lacquered colours, spessart oak and walnut c. Tall chest of drawers with 4 drawers and flap door with inner equipment, inside finishing in walnut veneer for lacquered chest of drawers and mat lacquered moka for spessart oak and walnut c. chest of drawers.

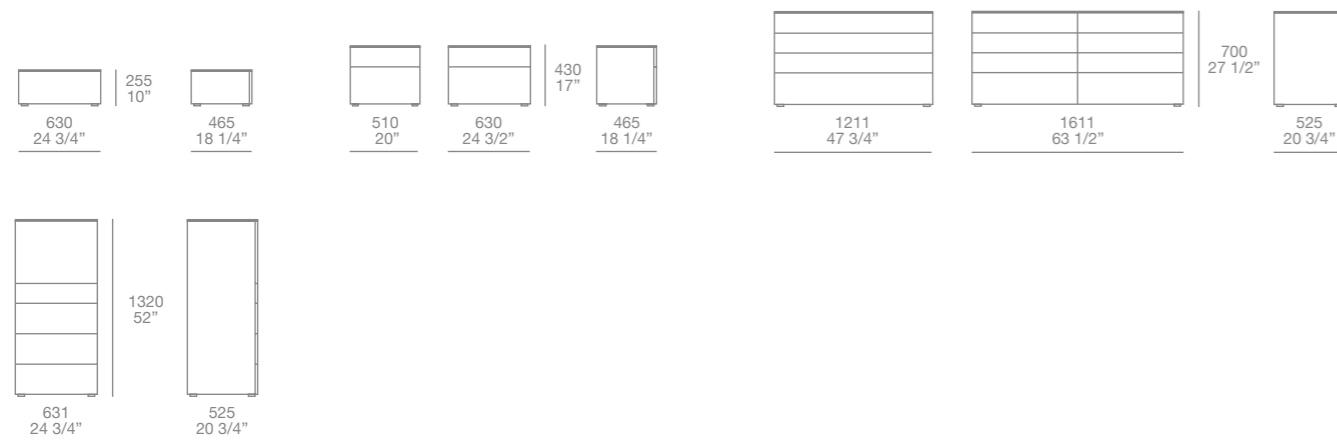

DREAM design Marcel Wanders

Laccato opaco colori, laccato lucido colori, noce c. (escluso pouf). Pouf contenitore laccato opaco colori, laccato lucido colori e liquido piombo con coperchio rivestito in tessuto e pelle. Piano scrittoio anche in rovere spessart.

pag 68

Mat lacquered colours, glossy lacquered colours and walnut c. Storage pouf mat, glossy lacquered colours and liquido piombo with top covered in fabric and leather. Desk shelf is available also in spessart oak.

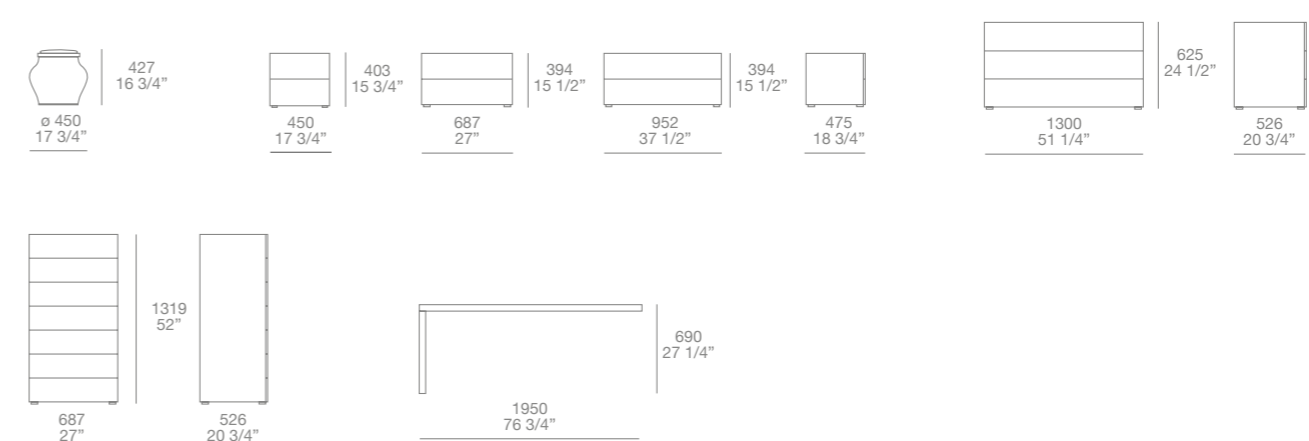

CONTENITORI / CONTAINERS

TECHNICAL DATA



TEO design Paolo Piva
Struttura e facciate noce c. e rovere spessart.

Walnut c. and spessart oak structure and fronts.

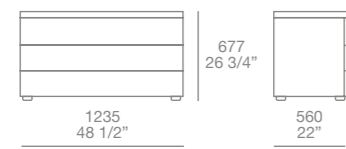

YOU design D. & T.
Struttura e frontali cassette noce c. e rovere spessart. Piedini in materiale plastico finitura nero e alluminio.

pag 198-201
Structure and drawer front in walnut c. and spessart oak. Feet in plastic material black and aluminium finishing.

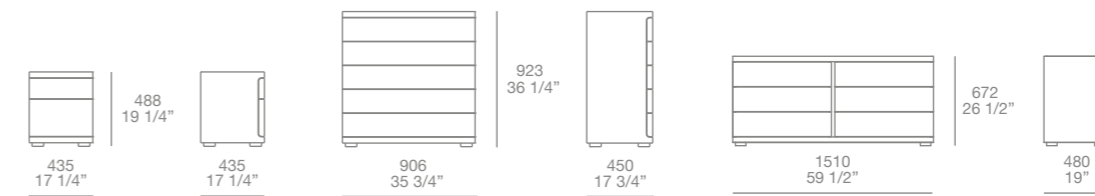

CONTENITORI / CONTAINERS

TECHNICAL DATA



TWEED design CR&S Poliform
Cassettiera ad isola in nobilitato rovere spessart, rovere cenere e noce c., 2 piani di appoggio rivestiti in tecnopelle e top in vetro; cassetti in nobilitato o vetro da un lato e ripiani inclinati dall'altro. Cassettini portagioie con serratura opzionali.

Island chest of drawers in spessart oak, cenere oak and walnut c. melamine, 2 tops covered in techno-leather and glass top; drawers in melamine or glass on one side and inclined shelves on the other. Optional jewellery drawers with key lock.

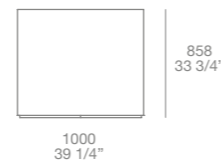
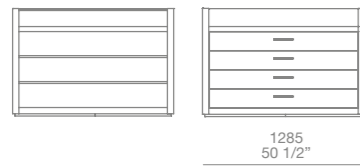

VICTOR design Mario Mazzer
Laccato opaco colori. Struttura in metallo verniciato cromato. Comodino alto con 1 cassetto.

Mat lacquered colours. Structure in chromed painted metal. Hight night table with 1 drawer.

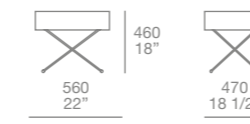

SPECCHI / MIRRORS

TECHNICAL DATA



EGO design CR&S Poliform
Specchio da fissare o da appoggio parete. Finiture: laccato opaco colori, laccato lucido colori, noce c. e rovere spessart. Specchio I 960 disponibile solo rivestito in cuoio.

Mirror to be leant against the wall or wall-mounted. Finishings: mat lacquered colours, glossy lacquered colours, walnut c and spessart oak. Mirror w 37 3/4" only available covered in hide.

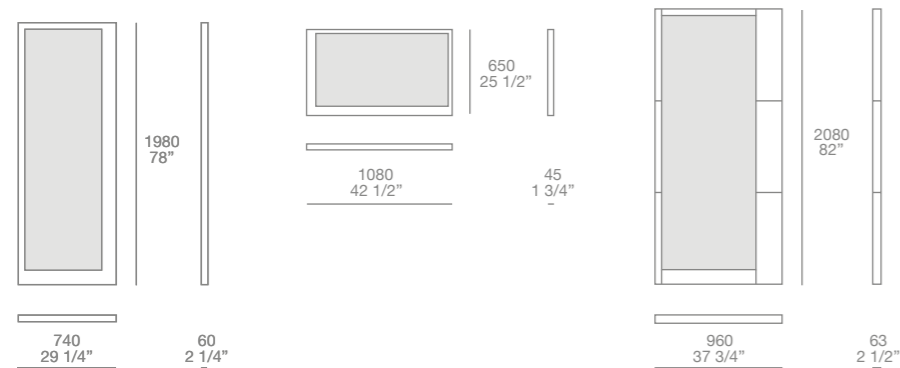

SARA design Flaviano Capriotti
Specchio da appoggio a parete. Finiture: cromo nero, laccato opaco colori, verniciato brown nickel opaco e lucido e rivestito in cuoio.

Mirror to be leant against the wall. Finishings: black chrome, mat lacquered colours, painted mat and glossy brown nickel and covered in hide.

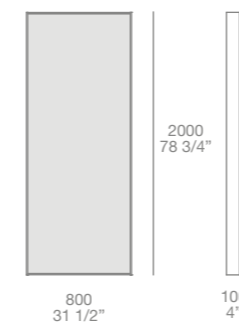

RETI / BEDSTEADS

Le reti Poliform sono progettate per garantire il miglior sostegno dinamico alla spina dorsale, distribuendo correttamente il peso del corpo e assicurando il corretto equilibrio fra elasticità di movimento e rigidità di supporto.

The bedsteads Poliform are projected to grant the best support for the spine, distributing the body weight evenly and assuring the right balance of firm support and flexibility in the movements.



Standard in legno a doghe. Rete in faggio con doghe flessibili montate ad incastro nel telaio perimetrale. Dimensioni mm l 1600-1800-2000 p 2000-2100 h 55

Standard bedstead in wood with slats. Beech-wood bedstead with flexible slats joint assembled. Dimensions in w 63"-70 3/4"-78 3/4" d 78 3/4"-82 3/4" h 2 1/4"



Fissa con doghe flessibili. Rete in faggio con doghe flessibili montate ad incastro nel telaio perimetrale. Dimensioni mm l 1600-1800-2000 p 2000-2100 h 55

Fixed bedstead with flexible slats. Beech-wood bedstead with flexible slats joint assembled. Dimensions in w 63"-70 3/4"-78 3/4" d 78 3/4"-82 3/4" h 2 1/4"



Anatomica con doghe flessibili. Rete in faggio con doghe flessibili montate a coppia su supporti in gomma, dotati di giunto ammortizzatore con abbassamento progressivo. Nella zona corrispondente al bacino le doghe sono raddoppiate, per assicurare un maggiore sostegno, e sono dotate di cursori per regolare la flessibilità. Dimensioni mm l 800-900-1000 p 2000-2100 h 70

Anatomic bedstead with flexible slats. Beech-wood bedstead with flexible slats fixed in pair on rubber supports, with shock absorbing joint with progressive lowering. In the pelvis area the slats are doubled to grant the best support and are provided of sliders to adjust the flexibility. Dimensions in w 31 1/2"-35 1/2"-39 1/4" d 78 3/4"-82 3/4" h 2 3/4"



Anatomica 1-2 con doghe flessibili. Rete in faggio con doghe flessibili montate a coppia su supporti in gomma, dotati di giunto ammortizzatore con abbassamento progressivo. Doghe raddoppiate nella zona lombare per assicurare un maggiore sostegno, con cursori per regolare la flessibilità. Disponibili con movimento manuale della sola testiera oppure di testiera e pediera. Consigliato l'utilizzo di materassi singoli di tipo standard o in lattice. Dimensioni mm l 800-900-1000 p 2000-2100 h 70

Anatomic bedstead 1 and 2 with flexible slats. Beech-wood bedstead with flexible slats fixed on pair on rubber supports, with shock absorbing joint with progressive lowering. In the pelvis area the slats are doubled to grant the best support and are provided of sliders to adjust the flexibility. The bedsteads are available with manual bed-head movement or with manual bed-head and footboard movement. We suggest the use of single standard mattresses or latex mattresses. Dimensions in w 31 1/2"-35 1/2"-39 1/4" d 78 3/4"-82 3/4" h 2 3/4"



Anatomica 3 con doghe flessibili. Rete in faggio con doghe flessibili mon-tate a coppia su supporti in gomma, dotati di giunto ammortizzatore con abbassamento progressivo. Doghe raddoppiate nella zona lombare per assicurare un maggiore sostegno, con cursori per regolare la flessibilità. 3 punti di snodo con movimento a motore elettrico, con telecomando a cavo flessibile. Arresto morbido a fine corsa. Motore con funzione di risparmio energetico e batteria di emergenza per funzionare anche in assenza di corrente. Consigliato l'utilizzo di materassi singoli in lattice. Dimensioni mm l 800-900-1000 p 2000-2100 h 70

Anatomic bedstead 3 with flexible slats. Beech-wood bedstead with flexible slats fixed on pair on rubber supports, with shock absorbing joint with progressive lowering. In the pelvis area the slats are doubled to grant the best support and are provided of sliders to adjust the flexibility. Three articulated joints with motor for electric regulation and flexible cable remote control. Soft stop at the end. Power saver motor with emergency battery for use without electric power. We suggest to use single latex mattresses. Dimensions in w 31 1/2"-35 1/2"-39 1/4" d 78 3/4"-82 3/4" h 2 3/4"

TECHNICAL DATA

MATERASSI LINEA NATURA / MATTRESSES NATURE LINE

Una scelta ecologica che coinvolge materiali naturali, biodegradabili e riciclabili, tecnologie di produzione a basso impatto ambientale e una nuova concezione del wellbeing, in cui il riposo è parte integrante della qualità della vita.

Dimensioni mm l 800-900-1000-1100-1600-1800-2000 p 2000-2100 h 160-180 / 6 1/4"-7"

An ecological choice which involves natural, biodegradable and recyclable materials, production technologies with low environmental impact and a new concept of well being, where rest is part of the quality of life.

Dimensions in w 31 1/2"-35 1/2"-39 3/4"-43 1/4"-63"-70 3/4"-78 3/4" d 78 3/4"-82 3/4" h 6 1/4"-7"



Soft 3. Materasso in lattice con 3 zone a densità variabile. Monoblocco in pura schiuma di lattice naturale alveolato, spessore 16 cm, conforme alle normative europee. Il lattice è un materiale ecologico, antibatterico e ipoallergenico. La sua densità, assimilabile ad un materasso ortopedico, assicura un sostegno ottimale alla colonna vertebrale e favorisce il rilassamento dei muscoli. Imbottitura termica con lato estivo in cotone cardato e stabilizzato e lato invernale in lana bianca agugliata. Il rivestimento è previsto in cotone 100% o in alternativa in tessuto antimicrobico Amicor Pure™ sfoderabile.

Soft 3. Three differentiated-support section latex mattress. Monobloc in pure natural latex foam thickness cm. 16 in accordance to European standards. Latex is an ecological healthy material. It is antibacterial and hypoallergenic. It modulates supporting capacity and elasticity, assuring the best support at different levels of the spine and allows relaxing of the vertebral and auxiliary muscles. Thermal padding with summer side in white carded and stabilized cotton and winter side in white needle-punched wool. The covering is in pure cotton 100% white colour or Amicor Pure™ anti mite removable fabric.



Soft 7. Materasso in lattice con 7 zone a densità variabile. Monoblocco in pura schiuma di lattice naturale alveolato, spessore 16 cm, conforme alle normative europee. Il lattice è un materiale ecologico, antibatterico e ipoallergenico. La sua densità, assimilabile ad un materasso ortopedico, assicura un sostegno ottimale alla colonna vertebrale e favorisce il rilassamento dei muscoli. Imbottitura termica con lato estivo in cotone cardato e stabilizzato e lato invernale in lana bianca agugliata. Il rivestimento è previsto in cotone 100% o in alternativa in tessuto antimicrobico Amicor Pure™ sfoderabile.

Soft 7. Seven differentiated-support section latex mattress. Monobloc in pure natural latex foam thickness cm. 16 in accordance to European standards. Latex is an ecological healthy material. It is antibacterial and hypoallergenic. It modulates supporting capacity and elasticity, assuring the best support at different levels of the spine and allows relaxing of the vertebral and auxiliary muscles. Thermal padding with summer side in white carded and stabilized cotton and winter side in white needle-punched wool. The covering is in pure cotton 100% white colour or Amicor Pure™ anti mite removable fabric.



Soft Plus. Materasso in lattice e fibra di cocco. Monoblocco con strato centrale in fibra di cocco igienizzata e strati esterni in pura schiuma di lattice naturale alveolato. La fibra di cocco è naturalmente dotata di un'elevata capacità traspirante, che garantisce caratteristiche di massima igienicità. Lavorata insieme al lattice, assicura un'ottimale risposta elastica e il miglior sostegno alla colonna vertebrale. Imbottitura termica con lato estivo in cotone cardato e stabilizzato e lato invernale in lana bianca agugliata. Il rivestimento è previsto in cotone 100% o in alternativa in tessuto antimicrobico Amicor Pure™ sfoderabile.

Soft Plus. Latex and coco, mattress. Monobloc made by combining a central sheet of hygienized antibacterial coconut fibre with two pure latex foam sheets. Coco fibre has a high aeration level which grants the best hygiene. The coco fibre is processed with latex and assures good elasticity and the best spine support. Thermal padding with summer side in white carded and stabilized cotton and winter side in white needle-punched wool. The covering is in pure cotton 100% white colour or Amicor Pure™ anti mite removable fabric.



Memory. Materasso in poliuretano e viscoelastico. Monoblocco con strato centrale in poliuretano indeformabile e traspirante, che offre una portanza ottimale, assimilabile ad un materasso ortopedico, associata ad uno spessore ridotto, rendendo così il materasso più leggero. Strati esterni in viscoelastico spessore 4 cm, che si adatta perfettamente al profilo del corpo e assicura il massimo ricambio d'aria all'interno del materasso, garantendo la massima igiene e un comfort superiore. Imbottitura termica con lato estivo in cotone cardato e stabilizzato e lato invernale in lana bianca agugliata. Il rivestimento è previsto in cotone 100% o in alternativa in tessuto antimicrobico Amicor Pure™ sfoderabile.

Memory. Polyurethane and visco-elastic foam mattress. Supporting monobloc in ecological polyurethane, non-deformable and with excellent air circulation, it offers the best support, similar to an orthopaedic mattress but with a thinner thickness which makes it lighter. External sheets in visco-elastic foam on both sides thickness 4 cm which perfectly adapts to the body shape and allows more air circulation inside the mattress, granting high levels of comfort and hygiene. Thermal padding with summer side in white carded and stabilized cotton and winter side in white needle-punched wool. The covering is in pure cotton 100% white colour or Amicor Pure™ anti mite removable fabric.



Memory 5. Materasso in poliuretano e viscoelastico a 5 zone differenziate. Supporto anatomico in poliuretano indeformabile, anallergico ed ecologico, che offre una portanza ottimale assimilabile ad un materasso ortopedico. Strati esterni in viscoelastico a zone differenziate, con sistema di areazione per garantire la massima igiene e un comfort superiore. Imbottitura termica con lato estivo in cotone cardato e stabilizzato e lato invernale in lana bianca agugliata. Il rivestimento è previsto in cotone 100% o in alternativa in tessuto antimicrobico Amicor Pure™ sfoderabile.

Memory 5. Polyurethane and visco-elastic foam mattress with five differentiated support-selections. Supporting anatomic monobloc in ecological non-deformable polyurethane which offers the best support, similar to an orthopaedic mattress. External sheets in visco-elastic foam with differentiated sections on both sides with air circulation system which grants high levels of comfort and hygiene. Thermal padding with summer side in white carded and stabilized cotton and winter side in white needle-punched wool. The covering is in pure cotton 100% white colour or Amicor Pure™ anti mite removable fabric.

La linea classica comprende i materassi a molle, i più vicini alla tradizione. Proposte che nell'interpretazione Poliform si arricchiscono di soluzioni tecnologicamente all'avanguardia e materiali dalla massima qualità.
dimensioni mm l 800-900-1000-1100-1600-1800-2000 p 2000-2100

The classic line includes the spring mattresses which are the closest to tradition.
A collection Poliform enriched by technological innovation and high quality materials to grant a choice always closer to individual needs.
dimensions in w 31 1/2"-35 1/2"-39 3/4"-43 1/4"-63"-70 3/4"-78 3/4" d 78 3/4"-82 3/4"

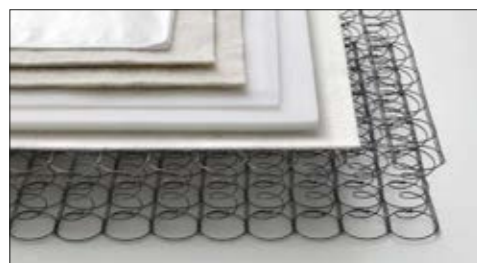

Comfort. Materasso a molle. Molle biconiche in filo di acciaio ad alta resistenza, densità circa 106 molle per mq. Conforme alla normativa italiana uni e alla normativa tedesca din. Imbottitura di irrigidimento in feltro agugliato e termofissato da entrambi i lati, per garantire la massima silenziosità. Imbottitura termica con lato estivo in cotone bianco stabilizzato e lato invernale in lana bianca agugliata. Il rivestimento è previsto in cotone 100% o in alternativa in tessuto antimicrobico Amicor Pure™ sfoderabile.

Comfort. Spring mattress with bi-conical springs in phosphatised tempered steel wire, about 106 springs per sqm. In accordance both to the Italian UNI and the German DIN regulation. Padding is in sound absorbent needle-punched thermo-fixed reinforcement felt on both sides. Thermal padding with summer side in white stabilized cotton and winter side in white needle-punched wool. The covering fabric is in pure cotton 100% or Amicor Pure™ anti mite removable fabric.

Dimensioni mm / dimensions in h 160-180 / 6 1/4"-7"

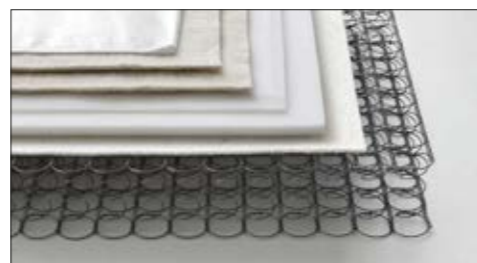

Ortopedico. Materasso a molle ad alta densità. Molle in filo di acciaio ad alta resistenza. La densità di circa 212 molle per mq garantisce il giusto equilibrio fra rigidità ed elasticità che definisce il corretto molleggio ortopedico. Conforme alla normativa italiana uni e alla normativa tedesca din. Imbottitura di irrigidimento in feltro agugliato e termofissato da entrambi i lati, per garantire la massima silenziosità. Imbottitura termica con lato estivo in cotone bianco stabilizzato e lato invernale in lana bianca agugliata. Il rivestimento è previsto in cotone 100% o in alternativa in tessuto antimicrobico Amicor Pure™ sfoderabile.

Orthopedic. Mattress with HD springs in high resistance phosphatised tempered steel wire. The density of about 212 springs per sqm grants the right balance of firm support and flexibility to give the right orthopaedic support. In accordance both to the Italian UNI and the German DIN regulation. Padding is in sound absorbent needle-punched thermo-fixed reinforcement felt. Thermal padding with summer side in white stabilized cotton and winter side in white needle-punched wool. The covering fabric is in pure cotton 100% or Amicor Pure™ anti mite removable fabric.

Dimensioni mm / dimensions in h 160-180 / 6 1/4"-7"

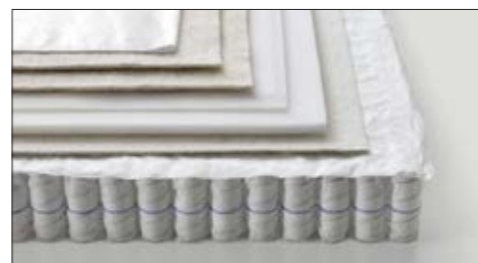

Relax. Materasso a molle insacchettate singolarmente. Molle in filo di acciaio rivestite singolarmente con guaina in fibertex per garantire il miglior sostegno e per adattarsi al corpo, assicurando il massimo comfort. Densità circa 238 molle per mq. Imbottitura di irrigidimento in feltro agugliato e termofissato, per garantire la massima silenziosità. Imbottitura termica con lato estivo in cotone bianco stabilizzato e lato invernale in lana bianca agugliata. Il rivestimento è previsto in cotone 100% o in alternativa in tessuto antimicrobico Amicor Pure™ sfoderabile.

Relax. Mattress with boxed springs in steel wire. Each spring is individually covered with fibertex; this ensures the best support to the human body. Density is about 238 springs per sqm. Padding in sound absorbent needle-punched reinforcement felt. Thermal padding with summer side in white carded and stabilized cotton and winter side in white needle-punched wool. The covering fabric is in pure cotton 100% white colour or Amicor Pure™ anti mite removable fabric.

Dimensioni mm / dimensions in h 160-180 / 6 1/4"-7"



Elite. Materasso a molle insacchettate indipendenti e viscoelastico h 25, con struttura box system, in filo di acciaio ø mm 1,80 h molla mm 140, circa 238 molle al mq. Ogni molla è rivestita singolarmente con fibertex e offre una completa indipendenza e un sostegno ideale in ogni punto del corpo. Feltro di rinforzo agugliato fonoassorbente. Lastre in materiale viscoelastico forato da entrambi i lati h cm 4. Questo materiale termosensibile si modella perfettamente alla forma del corpo, ed in grado di ritornare alla propria forma originale in modo graduale e costante, garantendo un supporto ottimale in ogni posizione. Imbottitura realizzata al 100% in cotone. Rivestimento interno 100% cotone jersey. Rivestimento non sfoderabile in tessuto trapuntato a mano di altissima qualità con trattamento antiacaro Sanitized®.

Elite. Mattress with independent boxed springs and viscoelastic foam h 25, with box system structure, in steel wire ø 1,80 mm, spring height 140 mm, about 238 springs per sqm. Each spring is individually covered with fibertex and offers a complete independence and an excellent support in each part of the body. Sound absorbent needle-punched reinforcement felt. Perforated visco-elastic sheets on both sides h 4 cm. This thermal sensitive material adapts perfectly to the shape of the body and returns to its original shape in a gradual and steady way, providing the best support whatever position. Padding made of 100% cotton. Internal cover in 100% jersey cotton. Non-removable hand-quilted top quality cover with Sanitized® anti mite treatment.

Dimensioni mm / dimensions in h 240/250 / 9 1/2"- 9 3/4"



Elite Plus. Materasso a micro molle insacchettate indipendenti, a zone differenziate e viscoelastico h 25, con struttura box system, in filo di acciaio ø mm 0,9 h. molla mm 140, circa 1000 molle al mq. Ogni molla è rivestita singolarmente con fibertex e offre una completa indipendenza e un sostegno ideale in ogni punto del corpo. Feltro di rinforzo agugliato fonoassorbente. Lastre in materiale viscoelastico da entrambi i lati h cm 4. Questo materiale termosensibile si modella perfettamente alla forma del corpo, ed in grado di ritornare alla propria forma originale in modo graduale e costante, garantendo un supporto ottimale in ogni posizione. Imbottitura realizzata al 100% in cotone. Rivestimento interno 100% cotone jersey. Rivestimento non sfoderabile in tessuto trapuntato a mano di altissima qualità con trattamento antiacaro Sanitized®.

Elite Plus. Mattress with independent boxed micro springs with differentiated zones and viscoelastic foam h 25, with box system structure, in steel wire ø 0,9 mm, spring height 140 mm, about 1000 springs per sqm. Each spring is individually covered with fibertex and offers a complete independence and an excellent support in each part of the body. Sound absorbent needle-punched reinforcement felt. Visco-elastic sheets on both sides h 4 cm. This thermal sensitive material adapts perfectly to the shape of the body and returns to its original shape in a gradual and steady way, providing the best support whatever position. Padding made of 100% cotton. Internal cover in 100% jersey cotton. Non-removable hand-quilted top quality cover with Sanitized® anti mite treatment.

Dimensioni mm / dimensions in h 240/250 / 9 1/2"- 9 3/4"



Luxor. Materasso a molle con rivestimento antiacaro Sanitized®. Molle in filo di acciaio insacchettate singolarmente con guaina in tessuto che previene la formazione di agenti patogeni. Punti termosaldati per garantire la massima silenziosità. Densità circa 260 molle per mq. Lastre su entrambi i lati in poliuretano espanso densità 40 kg al mq, indeformabili, elastiche ed esenti da cfc. Imbottitura a due strati realizzata al 100% in cotone. Rivestimento non sfoderabile in tessuto trapuntato a mano di altissima qualità con trattamento antiacaro Sanitized®.

Luxor. Spring mattress with Sanitized® anti-mite cover. Individual pocket steel wire springs with fabric sheath that prevents the formation of pathogens. Heat-welded mesh to guarantee the utmost noiselessness. Density of approximately 260 springs per sqm. Layers on both sides in polyurethane foam, density of 40 kg per sqm, shrink-resistant, stretch and CFC-free. Double-layer padding made of 100% cotton. Non-removable hand-quilted top quality cover with Sanitized® anti-mite treatment.

Dimensioni mm / dimensions in h 240/250 / 9 1/2"- 9 3/4"



Anatomico. Materasso a molle insacchettate con zone di portanza differenziata. Molle in filo di acciaio rivestite singolarmente con guaina in fibertex. Densità circa 280 molle per mq. Le 7 zone a portanza differenziata garantiscono una elevata capacità di adattamento al corpo nelle varie posizioni durante il sonno. Imbottitura di irrigidimento in feltro agugliato e termofissato, per la massima silenziosità. Imbottitura termica con lato estivo in cotone bianco stabilizzato e lato invernale in lana bianca agugliata. Il rivestimento è previsto in cotone 100% o in alternativa in tessuto antimicrobico Amicor Pure™ sfoderabile.

Anatomic. Mattress with boxed springs in steel wire with different carrying capacity sections. Each spring is individually covered with fibertex. About 280 springs per sqm. The 7 different carrying sections grant the capability to adapt to the different points of pressure exercised by the human body during sleep. Padding in sound absorbent needle-punched reinforcement felt. Thermal padding with summer side in white carded and stabilized cotton and winter side in white needle-punched wool. Covering in pure cotton 100% white colour or Amicor Pure™ anti mite removable fabric.

Dimensioni mm / dimensions in h 160-180 / 6 1/4"-7"



Benessere. Materasso a molle e viscoelastico. Molle in filo di acciaio rivestite singolarmente con guaina in fibertex. Densità circa 238 molle per mq. Imbottitura di irrigidimento in feltro fonoassorbente e in materiale viscoelastico che si modella perfettamente al profilo del corpo. Il viscoelastico recupera la propria forma originaria in modo graduale e costante, garantendo così un supporto ottimale in ogni posizione. Imbottitura termica con lato estivo in cotone bianco stabilizzato e lato invernale in lana bianca agugliata. Il rivestimento è previsto in cotone 100% o in alternativa in tessuto antimicrobico Amicor Pure™ sfoderabile.

Wellness. Mattress with independent boxed springs and visco-elastic foam. Each spring is individually covered with fibertex. Density is about 238 springs per sqm. Padding in sound absorbent needle-punched reinforcement felt and in visco-elastic material which perfectly adapts to the shape of the body. The visco-elastic foam returns to its original shape in a gradual and steady way, providing the best support whatever position. Thermal padding with summer side in white stabilized cotton and winter side in white needle-punched wool. Covering in pure cotton 100% white colour or Amicor Pure™ anti mite removable cover.

Dimensioni mm / dimensions in h 180-200 / 7"- 7 3/4"



Benessere Plus. Materasso a molle e viscoelastico con rivestimento antiacaro. Molle in filo di acciaio rivestite singolarmente con guaina in fibertex. Densità circa 238 molle per mq. Imbottitura di irrigidimento in feltro fonoassorbente e in materiale viscoelastico che si modella perfettamente al profilo del corpo. Il viscoelastico recupera la propria forma originaria in modo graduale e costante, garantendo così un supporto ottimale in ogni posizione. Imbottitura 100% in fibra anallergica. Rivestimento sfoderabile in tessuto antimicrobico Amicor Pure™ sfoderabile.

Wellness Plus. Spring mattress in visco-elastic foam with anti mite covering. Springs in steel wire individually covered with fibertex. Density about 238 springs per sqm. Padding in sound absorbent needle-punched reinforcement felt and visco-elastic material which perfectly adapts to the body shape. The visco-elastic foam returns to its original shape in a gradual and steady way, providing the best support whatever position. Padding realised in 100% anti-allergenic fibre. Removable covering in Amicor Pure™ anti mite fabric.

Dimensioni mm / dimensions in h 240/250 / 9 1/2"- 9 3/4"

RIVESTIMENTI MATERASSI / MATTRESS COVERS

Il rivestimento dei materassi è una componente essenziale del progetto della zona notte: una scelta corretta è fondamentale per assicurare un riposo sano e salubre. La collezione Poliform prevede un rivestimento tradizionale in cotone a cui si affiancano due proposte dedicate al massimo benessere, con gli innovativi tessuti Amicor Pure™ e Sanitized® che garantiscono l'eliminazione degli allergeni e degli acari presenti nei materassi.



Personalizzato Poliform. Rivestimento in puro cotone di colore bianco. Lavorazione a trapunta con disegno a rombi stilizzati. Fascia perimetrale trapuntata con 4 maniglie in puro cotone.

Amicor Pure™ sfoderabile. Rivestimento sfoderabile in tessuto antimicrobico Amicor Pure™, una fibra che grazie ad un meccanismo di diffusione costante eroga un additivo sicuro per la pelle e l'ambiente, che elimina gli allergeni e i microbi che abitualmente si annidano nei materassi. Il rivestimento può essere lavato senza comprometterne l'effetto antimicrobico.

Rivestimento Antiacaro Sanitized®. Rivestimento non sfoderabile in tessuto antiacaro Sanitized®, una fibra che possiede proprietà fungo-batteriostatiche e antiacaro. I principi attivi sono innocui per la pelle e integrati nelle fibre, senza alcun trattamento superficiale.

The mattress cover is an essential component of the bedroom project: the correct choice is vital to ensure a healthy good night's sleep.

The Poliform range offers a traditional non-removable cotton cover and two further options to reach the maximum well-being with the innovative fabrics Amicor Pure™ and Sanitized® that eliminate allergens and mites, usually present in the mattresses.



Poliform personalized. Cover in pure white cotton quilted with a stitched diamond pattern. The perimetric band is quilted and provided of 4 handles in pure cotton.

Removable cover Amicor Pure™. Removable cover in anti-microbial fabric Amicor Pure™. Amicor Pure™ is a fibre that thanks to a slow spreading mechanism supplies a barely adequate quantity of a safe additive for both the skin and the environment. This substance eliminates allergens and microbes which are usually in mattresses. The effect is not eliminated by washing the cover and does not end with the use.

Non-removable cover Anti Mite Sanitized®. The anti mite fabric Sanitized® is a fibre with bacteriostatic-antifungal properties and it is also effective against mites. The integrated active substances are harmless for the skin and there is no surface chemical treatment.

TECHNICAL DATA

GUANCIALI / PILLOWS

L'ampiezza della collezione guanciali Poliform sottolinea la volontà di offrire soluzioni in grado di adattarsi sempre di più alle esigenze individuali e alle diverse posizioni del riposo. Per i piumini varietà di soluzioni accomunate dalla qualità dei materiali e delle rifiniture. Dalla piuma d'oca al Dacron, fino al piumino formato da due inserti utilizzabili separatamente o insieme.



Ortopedico. Anima interna in poliuretano con forma anatomica, imbottitura in ovatta di poliestere traspirante DuPont. L'appoggio ottimale per il collo lascia le vertebre cervicali rilassate, per un'azione preventiva dei disturbi legati alla cervicale.

Ortopedic. Inner core in polyurethane foam anatomic shaped, padding in aerating polyester DuPont. The best neck support allows cervical vertebra to relax to prevent cervical troubles.



Lana. Imbottitura in pura lana vergine 100%. Tradizione e naturalezza per un materiale sempre attuale. Di grande sofficià, ha elevate qualità di assorbimento dell'umidità, garantendo il massimo comfort in tutte le stagioni.

Wool. Padding in pure virgin wool 100%. This traditional and natural fibres of great softness naturally absorb moisture vapour providing the best comfort in the heat of summer and on cold winter nights.



Piuma d'oca. Imbottitura in 100% piuma d'oca sterilizzata. Le alte capacità traspiranti garantiscono una temperatura di riposo uniforme. Assorbe in modo eccellente l'umidità e favorisce l'evaporazione del calore in eccesso.

Goose feathers. Padding in goose feathers 100%. Thanks to the high ventilation temperature will remain static throughout the night. It absorbs humidity and lets exceeding heat evaporate.

The wide range of Poliform pillows shows the care of the company to adapt to individual needs and the several positions during rest.

A duvet collection with a great variety of high quality materials and finishings. From goose feathers to Dacron, and the eiderdown composed of two inserts which can be used separately or together.



Dacron Dupont. Imbottitura in ovatta di poliestere traspirante. Igienico, anallergico e di facile manutenzione. Offre una piacevole sensazione di sofficià e comfort, adattandosi alla testa e al collo, tornando poi alla propria forma.

Dacron Dupont. Padding in aerating polyester DuPont. Hygienic, anti-allergenic and easy to maintain. This pillow offers a pleasant sensation of softness and comfort, adapting to head and neck and returning to the original shape in a slow way.



Lattice. Anima interna in pura schiuma di lattice alveolato. Garantisce la traspirazione, mantenendo la temperatura costante e assicurando una sensazione di freschezza. Anatomico, ha proprietà antibatteriche e ipoallergeniche.

Latex. Inner core in pure honeycombed latex foam. This pillow grants aeration keeping the temperature constant and assuring a sensation of freshness. It is anatomic, anti-allergenic and antibacterial.



Viscoelastico. Anima interna in viscoelastico alveolato. Traspirante per garantire la massima igiene. Con il calore del corpo il guanciale si adatta alla conformazione del corpo, consentendo al collo di assumere la posizione più confortevole.

Visco-elastic foam. Inner core in honeycombed visco-elastic foam. Aeration grants the utmost hygiene. The pillow models itself according to the warmth and shape of the body, allowing the neck to get the proper position.



Conforel Dupont. Imbottitura in microsferi in fibra di poliestere, progettate per resistere allo schiacciamento. Il guanciale si modella seguendo la forma della testa e del collo e adattandosi ai movimenti. Lavabile in lavatrice.

Conforel Dupont. Padding with polyester fibre microspheres projected to resist to crushing. The pillow models itself following the shape of head and neck and adapts to movements. Machine washable.



Lattice cervicale. Anima interna in pura schiuma di lattice alveolato e sagomato con forma anatomica per appoggio della zona cervicale. Le due onde sono di diverse altezze: è sufficiente ruotare il guanciale per trovare il miglior sostegno sul collo.

Cervical latex. Inner core in pure honeycombed latex foam and anatomic shaped for cervical support. The two waves have different heights: it is enough to turn the pillow to find the best neck support.



Viscoelastico cervicale. Anima interna in viscoelastico alveolato e sagomato. La particolare forma a doppia onda, di altezze diverse, è studiata appositamente per migliorare la postura delle vertebre cervicali, rilassando collo e spalle durante il sonno.

Cervical visco-elastic foam. Inner core in honeycombed shaped visco-elastic foam. The peculiar shape with two waves of different heights is projected to improve the posture of the cervical spine, relaxing neck and shoulders during sleep.

GUANCIALI / PILLOWS



Guanciale grande. Imbottitura disponibile in 9 versioni (vedi pag precedente), fodera 100% cotone.
Big pillow. Padding available in 9 versions (see previous page), cover 100% cotton.
 dimensioni mm / dimensions in
 500 x 800 - 19 3/4" x 31 1/2"



Cuscino piccolo. Imbottitura disponibile in 3 versioni: dacron DuPont, conforel DuPont e piuma d'oca, fodera 100% cotone.
Small cushion. Padding available in 3 versions: dacron DuPont, conforel DuPont and feathers, cover 100% cotton.
 dimensioni mm / dimensions in
 420 x 420 - 16 1/2" x 16 1/2"



Guanciale piccolo. Imbottitura disponibile in 3 versioni: dacron DuPont, conforel DuPont e piuma d'oca, fodera 100% cotone.
Small pillow. Padding available in 3 versions: dacron DuPont, conforel DuPont and feathers, cover 100% cotton.
 dimensioni mm / dimensions in
 400 x 600 - 15 3/4" x 23 1/2"



Cuscino grande. Imbottitura disponibile in 3 versioni: dacron DuPont, conforel DuPont e piuma d'oca, fodera 100% cotone.
Big cushion. Padding available in 3 versions: dacron DuPont, conforel DuPont and feathers, cover 100% cotton.
 dimensioni mm / dimensions in
 620 x 620 - 24 1/2" x 24 1/2"



Rulli. Imbottitura in dacron, fodera 100% cotone, rivestimento da campionario.
Roll-cushion. Padding in dacron, cover 100% cotton, available in the fabrics of the collection
 dimensioni mm / dimensions in
 l 780 - 800 - 880 - 900 Ø 200
 w 30 3/4"-31 1/2"- 34 3/4"- 35 1/2" Ø 7 3/4"

INSERTI PIUMINI / DUVETS



Piuma 50/50. Imbottitura 50% piumino, 50% piumetta d'oca/anatra da gr. 325/mq, fodera 100% cotone.
Duvet in feather. Stuffed with 50% down and 50% plumule of goose/duck of 325 grams per sqm, lining 100% cotton.



Piuma special 100. Imbottitura 90% piumino, 10% piumetta d'oca/anatra da gr. 240/mq, fodera 100% cotone.
Feather special 100. Stuffed with 90% down, 10% plumule of goose/duck of 240 grams per sqm, lining 100% cotton.



Dacron. Imbottitura in dacron DuPont, fodera 100% cotone.
Dacron. Stuffed with Dacron DuPont, cover 100% cotton.



Doppia stagione. Imbottitura fiberfill, formato da 2 inserti accoppiati e utilizzabili separatamente.
Fiberfill "double season". Stuffed with fiberfill, composed of two coupled inserts which can be used separately.

TECHNICAL DATA

COLLEZIONE BIANCHERIA / LINEN COLLECTION

Biancheria letto coordinata in cotone con una gamma di 7 colori e decoro a "codà di topo" nero a contrasto o tono su tono.

Cotton bed linen in 7 colours and "rat-tail" decoration back or tone on tone.

Cotone Provence / Cotton Provence



01 bianco

08 polvere

02 panna

04 tortora



03 ghiaccio

06 roccia

07 grafite

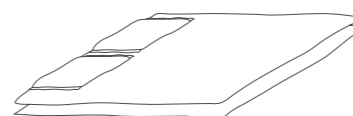

Set estivo. 2 federe guanciale grande, lenzuolo sotto, lenzuolo sopra. Disponibile per larghezze rif materasso l 1000-1400-1600-1800-2000.

Summer bed-set. 2 big pillow cases, fitted sheet, top sheet. Available for mattress width ref. w 39 1/4"-55"-63"-70 3/4"-78 3/4".

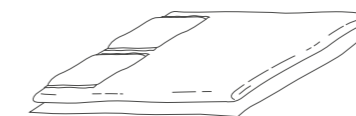

Set invernale. 2 federe guanciale grande, lenzuolo sotto, copripiumino. Disponibile per larghezze rif materasso l 1000-1400-1600-1800-2000.

Winter bed-set. 2 big pillow cases, fitted sheet, top sheet, duvet cover. Available for mattress width ref. w 39 1/4"-55"-63"-70 3/4"-78 3/4".



Federe. Per guanciali grande e piccolo e cuscini grande e piccolo.

Cases. For big and small pillow, for big and small cushion.



Lenzuolo sotto/sopra. Disponibile per larghezze rif materasso l 1000-1400-1600-1800-2000.

Sheet/under sheet. Available for mattress width ref. w 39 1/4"-55"-63"-70 3/4"-78 3/4".

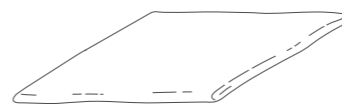

Sacco copripiumino. Disponibile per larghezze rif materasso l 1000-1400-1600-1800-2000.

Eiderdown cover. Available for mattress width ref. w 39 1/4"-55"-63"-70 3/4"-78 3/4".

COLLEZIONE TAPPETI / CARPET COLLECTION

TECHNICAL DATA

Tutti i tappeti della collezione sono realizzati a mano con tecnica Hand Loom, materiali naturali privi di agenti chimici e trattamenti acidi. Attenti accostamenti cromatici per proposte stilisticamente differenti, pensate per il completamento degli allestimenti e delle soluzioni d'arredo Poliform.

All the carpets in the collection are created on a Hand Loom, using natural materials with no chemical agents or acid treatments. Careful colour combinations offer stylistically different solutions, designed to complete Poliform interior design projects.



SOFT
Trama cotone, vello lana grigio sfumato, senza frange.
Cotton weave, fur light grey wool, without fringes.
Dimensioni mm / dimensions in
1700 x 2400 / 67"x 94 1/2"
2300 x 3000 / 90 1/2"x 118"
3000 x 4000 / 118"x 157 1/2"



PLAIN NATURAL
Trama cotone, vello aloe e bamboo silk, senza frange.
Cotton weave, fur aloe and bamboo silk, without fringes.
Dimensioni mm / dimensions in
1700 x 2400 / 67"x 94 1/2"
2300 x 3000 / 90 1/2"x 118"
3000 x 4000 / 118"x 157 1/2"



PLAIN GRAY
Trama cotone, vello aloe e bamboo silk, senza frange.
Cotton weave, fur aloe and bamboo silk, without fringes.
Dimensioni mm / dimensions in
1700 x 2400 / 67"x 94 1/2"
2300 x 3000 / 90 1/2"x 118"
3000 x 4000 / 118"x 157 1/2"



STRIPES
Trama cotone, vello lana e bamboo silk, senza frange.
Cotton weave, fur wool and bamboo silk, without fringes.
Dimensioni mm / dimensions in
800 x 3000 / 31 1/2" x 118"
1700 x 2400 / 67"x 94 1/2"
2300 x 3000 / 90 1/2"x 118"
3000 x 4000 / 118"x 157 1/2"



DAMA
Trama cotone, vello lana e bamboo silk, senza frange.
Cotton weave, fur wool and bamboo silk, without fringes.
Dimensioni mm / dimensions in
800 x 3000 / 31 1/2" x 118"
1700 x 2400 / 67"x 94 1/2"
2300 x 3000 / 90 1/2"x 118"
3000 x 4000 / 118"x 157 1/2"



DAMA NATURAL
Trama cotone, vello lana e bamboo silk, senza frange.
Cotton weave, fur wool and bamboo silk, without fringes.
Dimensioni mm / dimensions in
800 x 3000 / 31 1/2" x 118"
1700 x 2400 / 67"x 94 1/2"
2300 x 3000 / 90 1/2"x 118"
3000 x 4000 / 118"x 157 1/2"



FRAME GOLD
Trama cotone, vello bamboo silk, bordo mm 80.
Cotton weave, fur bamboo silk, edge 3 1/4".
Dimensioni mm / dimensions in
1700 x 2400 / 67"x 94 1/2"
2300 x 3000 / 90 1/2"x 118"
3000 x 4000 / 118"x 157 1/2"

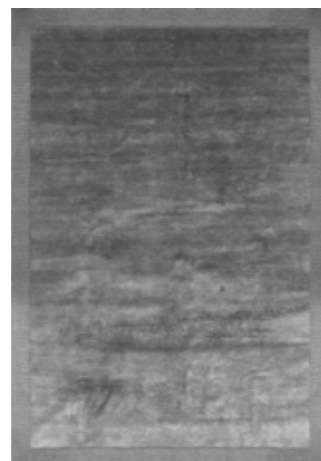

FRAME GRAY
Trama cotone, vello bamboo silk, bordo mm 80.
Cotton weave, fur bamboo silk, edge 3 1/4".
Dimensioni mm / dimensions in
1700 x 2400 / 67"x 94 1/2"
2300 x 3000 / 90 1/2"x 118"
3000 x 4000 / 118"x 157 1/2"

FINITURE / FINISHINGS

TECHNICAL DATA

LACCATO OPACO E LUCIDO / MAT AND GLOSSY LACQUERED

■ solo laccato opaco / only mat lacquered
▲ antigraffio / also anti-scratch



* TECNOPELLE / TECHNO-LEATHER

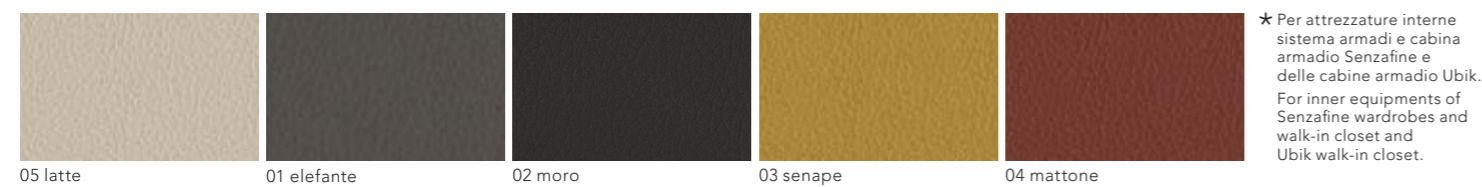

* Per attrezzature interne sistema armadi e cabina armadio Senzafine e delle cabine armadio Ubik. For inner equipments of Senzafine wardrobes and walk-in closet and Ubik walk-in closet.

ESSENZE / WOODS



INTERNO CASSETTI / DRAWERS STRUCTURE

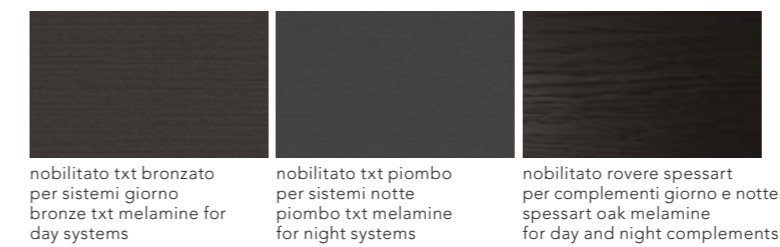

NOBILITATI STRUTTURE E ATTREZZATURE SENZAFINE E UBIK / SENZAFINE AND UBIK MELAMINE STRUCTURE AND EQUIPMENTS



* Nobilitato larice bianco: solo per sistema armadi e cabina armadio Senzafine. White larch melamine: only for Senzafine wardrobes and walk-in closet.

NOBILITATI FACCIATE SENZAFINE / SENZAFINE MELAMINE DOORS

● laccato opaco 27 colori / 27 mat lacquered colours



* Nobilitato Skin anche per pannellatura Ubik. Skin melamine available also for Ubik back panels.

ACRILICO / ACRYLIC



FINITURE / FINISHINGS

TECHNICAL DATA

VETRO SATINATO / MAT GLASS



2301 bianco extrachiaro white extralight 2373 ghiaccio 1335 canapa 1364 arena 1304 grafite 1303 nero

VETRO LUCIDO / GLOSSY GLASS



2201 bianco extrachiaro white extralight 2273 ghiaccio 1235 canapa 1264 arena 1204 grafite 1203 nero

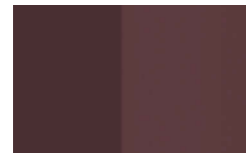

1259 bordeaux

VETRO / GLASS

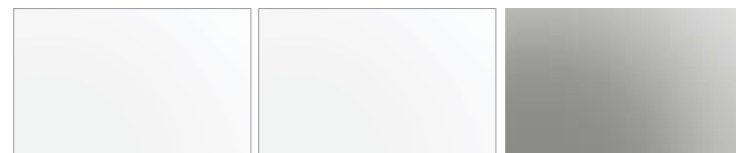

1000 trasparente 1000 transparent 2000 trasparente extrachiaro 2000 transparent extralight 3050 fumé 3050 fumé

VETRO RIFLETTENTE / REFLECTING GLASS



5000 trasparente 5000 transparent 5010 blu 5010 blue 5051 bronzato 5051 bronzed 5059 fumé 5059 fumé

SPECCHIO / MIRROR

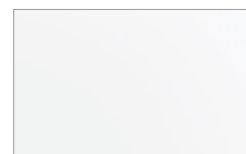

4000 bianco 4000 white

MARMO LEVIGATO / MAT MARBLE

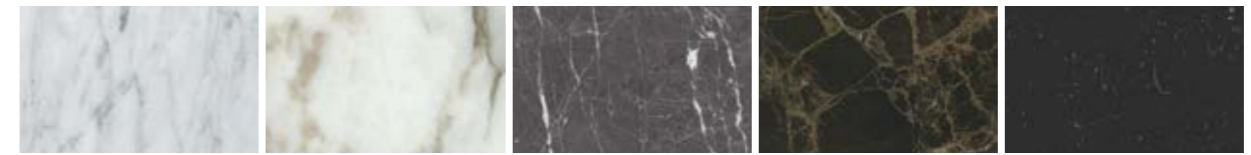

bianco carrara calacatta oro grigio stardust emperador dark petit granit

MARMO LUCIDO / GLOSSY MARBLE

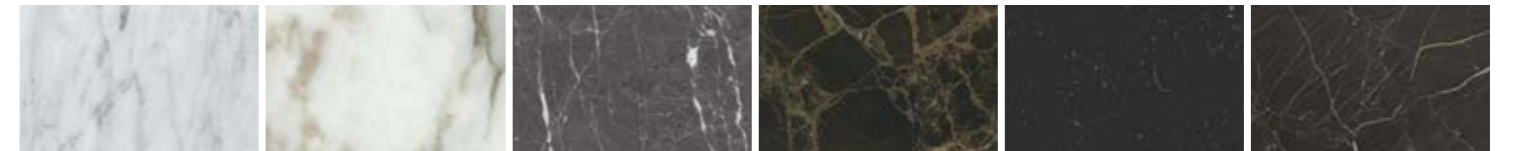

bianco carrara calacatta oro grigio stardust emperador dark petit granit noir saint laurent

PARTI METALLICHE / METAL PARTS



piombo opaco/mat cromo nero black chrome fusione di bronzo lucidata oro polished gold bronze-casting bronzo anticato antique bronze oro lucido glossy gold oro satinato gold satin



brown nickel opaco mat brown nickel brown nickel lucido glossy brown nickel

METALLI LIQUIDI / LIQUID METAL PAINTING

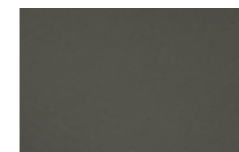

piombo

FINITURE / FINISHINGS

TECHNICAL DATA

TESSUTI / FABRICS



PELLE / LEATHER



CUOIO / HIDE



BORDURE E CUCITURE / BORDERS AND STITCHES

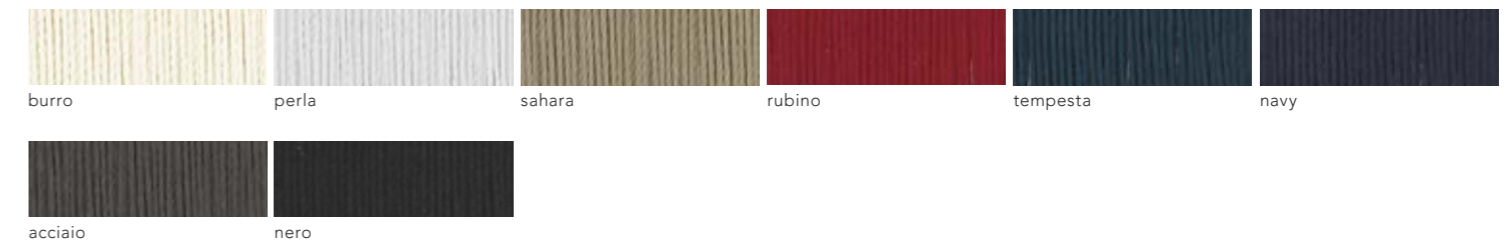

COLLEZIONE BIANCHERIA / LINEN COLLECTION

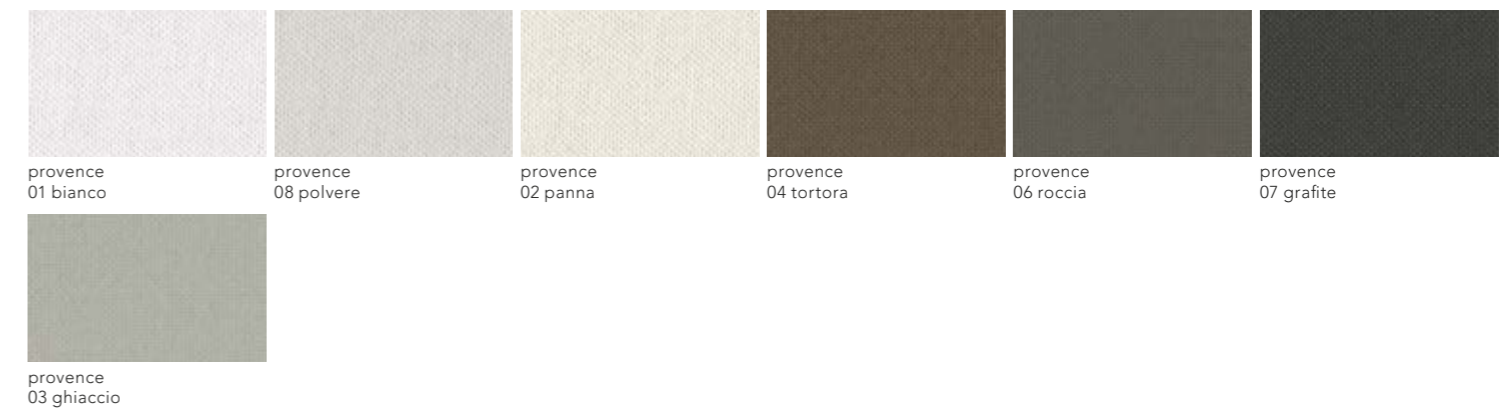

Poliform si riserva il diritto di apportare, senza preavviso, ogni modifica mirata al miglioramento funzionale e qualitativo dei propri prodotti. Testi e disegni presenti in questo stampato hanno scopo divulgativo: per ogni aspetto tecnico e dimensionale fare riferimento ai listini aziendali e relativi aggiornamenti. I campioni di colori e materiali hanno valore indicativo.

Poliform reserves the rights at all time to apply modifications for the functional or qualitative improvement of its products. Texts and drawings present in this brochure have a divulgative purpose: for every technical and dimensional aspect please refer to the company's price lists and their relative updatings. The colour and material samples have an indicative value.

Art Direction: Paolo Mojoli e Poliform lab
Photo: Federico Cedrone
Styling: Poliform lab

1° EDIZIONE APRILE 2017
COD. 96/R1/2017

thanks to:

A.G. Spalding&Bros
Alberto Levi Gallery www.albertolevi.com
American Vintage
Andrea Baumann
Aquilano Rimondi
Araldi 1930
Arcarreda
Azucena
Azzurra Gronchi
Bertoni 1949
Böle Tannery
Borsalino
Canova Milano
Car Shoe
Cartier
Ceramiche Gambone di Bruno Gambone
Chisel&Mouse
Claudio Brocchini
Coltelleria O. Lorenzi www.o-lorenzi.it
Church's
Comelaria
CC-Tapis
Cto lighting
Design Inverso
Discipline
Doria 1905
Ernesto Esposito
Estel per Artecuoio
Eton
Fontana Arte
Flos
Gedebe
Ghidini 1961
Gubi

Guax
I and I
Ivano Redaelli
Kallisté
Kammi
Kasthall
Kinloch
Laboratorio Avallone
Lerre
Leucos
Lobmeyr
Lubinski
Luciano Padovan
L.P. s.n.c. di Lunghi Mattia & Pezzetta Antonio
Marc Wave
Malloni
Manuel Ritz
Marina Fossati
Mc Mottadelli
Moreschi
Morie Nishimura
Minimalux
Move it di XAL www.xal.com
Nahoor - Limelight
Nomess Copenhagen
Nude Glass
Otto D'Ame
Paoloni
Paloma Barcelò
Parachilna
Pia Wustenberg
Piemme di Pellegatta Matteo
Piazza Sempione
Pignatelli

Roberto Botticelli
RestartMilano
Salvioni
Sebastian
Sermoneta Gloves
Simose di Simo Serpola
Smoothline di Eclettis www.eclettis.it
Sharra Pagano
Shirtaporter
Skultuna 1607
Stroili
Tagliatore
Trussardi
Techimpex
Tj International Design per Tom Dixon
Tumi
Valenti Luce
Valextra
Vladimiro Gioia
Venicem
vij5/Arjan Van Raadshooven
Vistosi
When Objects Work
Younique Plus



